

GENERATION 2 QUADRATHERM® Heater

Low Pressure 24 Volt Direct Spark Ignition

FOR YOUR SAFETY

If you smell gas:

- 1. Open Windows**
- 2. Do not touch electrical switches**
- 3. Extinguish any open flames**
- 4. Immediately call your gas supplier**

FOR YOUR SAFETY

Do not store or use gasoline or other flammable vapors and liquids in the vicinity of this or any other appliance

Note: The original, authoritative version of this manual is the English version produced by CTB, Inc. or any of its subsidiaries or divisions, hereafter collectively referred to as "CTB"). Subsequent changes to any manual made by any third party have not been reviewed nor authenticated by CTB. Such changes may include, but are not limited to, translation into languages other than English, and additions to or deletions from the original content. CTB disclaims responsibility for any and all damages, injuries, warranty claims and/or any other claims of any nature associated with such changes, inasmuch as such changes result in content that is different from the authoritative CTB-published English version of the manual. For current product installation and operation information, please contact the customer service and/or technical service departments of the appropriate CTB subsidiary or division. Should you observe any questionable content in any manual, please notify CTB immediately in writing directed to: CTB Legal Department, P.O. Box 2000, Milford, IN 46542-2000 USA.

WARRANTY

CTB, Inc. warrants each new product manufactured by it to be free from defects in material or workmanship for one (1) year from and after the date of initial installation by or for the original purchaser. If such a defect is found by Manufacturer to exist within the one-year period, the Manufacturer will, at its option, (a) repair or replace such product free of charge, F.O.B. the factory of manufacture, or (b) refund to the original purchaser the original purchase price, in lieu of such repair or replacement. Labor costs associated with the replacement or repair of the product are not covered by the Manufacturer.

Conditions and Limitations

1. The product must be installed by and operated in accordance with the instructions published by the **Manufacturer or Warranty will be void.**
2. Warranty is void if **all components** of the system are not original equipment supplied by the **Manufacturer.**
3. This product must be purchased from and installed by an authorized distributor or installer or a certified representative thereof **or the Warranty will be void.**
4. Malfunctions or failure resulting from misuse, abuse, negligence, alteration, accident, or lack of proper maintenance, or from lightning strikes, electrical power surges or interruption of electricity, shall not be considered defects under the Warranty.
5. This Warranty applies only to systems for the care of poultry and livestock. Other applications in industry, commerce, or residential applications are not covered by this Warranty and are **strictly prohibited.** Any such use **will void the Warranty.**

Manufacturer shall not be liable for any **Consequential or Special Damage** which any purchaser may suffer or claim to suffer as a result of any defect in the product. *“Consequential” or “Special Damages” as used herein include, but are not limited to, lost or damaged products or goods, costs of transportation, lost sales, lost orders, lost income, increased overhead, labor and incidental costs and operational inefficiencies.*

THIS WARRANTY CONSTITUTES THE MANUFACTURER’S ENTIRE AND SOLE WARRANTY AND THIS MANUFACTURER EXPRESSLY DISCLAIMS ANY AND ALL OTHER WARRANTIES, INCLUDING, BUT NOT LIMITED TO, EXPRESS AND IMPLIED WARRANTIES AS TO MERCHANTABILITY, FITNESS FOR PARTICULAR PURPOSES SOLD AND DESCRIPTION OR QUALITY OF THE PRODUCT FURNISHED HEREUNDER.











Distributors are not authorized to modify or extend the terms and conditions of this Warranty in any manner or to offer or grant any other warranties for the products in addition to those terms expressly stated above. An officer of the Manufacturer must authorize any exceptions to this Warranty in writing. Manufacturer reserves the right to change models and specifications at any time without notice or obligation to improve previous models.

Effective 08/08

Chore-Time Equipment
A Division of CTB, Inc.
P.O. Box 2000 Milford, Indiana 46542-2000 USA
Ph.: 574-658-4101 Fax: 877-730-5525
Email: ctb@ctbinc.com
Internet: <http://www.ctbinc.com>

WARNING!

SERIOUS PERSONAL INJURY AND/OR DEATH MAY RESULT FROM USE OF THIS HEATER IN AN UNVENTILATED BUILDING OR IN HUMAN LIVING AREAS.

-  Do not use the heater to heat human living areas. The intended use of the heater is to provide warmth for poultry and hog buildings
-  Use only the type of gas being supplied to the unit as marked on it (Propane or Natural Gas). Do not operate with improper fuel.
-  Before each use, a visual inspection of the heater is essential to insure safety and satisfactory heating. Replace or repair defective components before operating heater. Failure to do so will void warranty and could result in injury and property damage.
-  **WARNING:** Improper installation, adjustments, alteration, service or maintenance could cause property damage, injury or death. Read the installation, operating and maintenance instructions thoroughly before installing or servicing this equipment.
-  **WARNING:** Failure to follow WARNINGS in this manual could result in serious injury or significant property damage.
-  Before lighting, sniff all around the appliance area for a gas odor. Be sure to sniff next to the floor because propane gas is heavier than air and may temporarily exist at floor level.
-  **DO NOT ALLOW POWER CORDS AND/OR GAS SUPPLY HOSES TO REST ON THEIR CANOPY, HANGING BRACKETS OR OTHER HOT SURFACES OF THE UNIT OR TO COME WITHIN 12" OF THE HEATER.**
-  **DSI UNITS MUST BE PROPERLY GROUNDED. DO NOT ALTER ELECTRICAL CORD.**
-  Plug in the three-prong power cord to a correctly grounded three-prong electrical outlet.
-  The installation of this appliance must in all cases conform with local and national building codes or in the absence of local codes to the current National Fuel Gas Code ANSI Z223.1/NFPA 54, or the Natural Gas and Propane Installation Codes, CSA B149.1 and B149.2.
-  Heaters must be electrically grounded in accordance with the National Electrical Code, ANSI/NFPA 70 or the current Canadian Electrical Code, CSA C22.1. Polarity of Line voltage and neutral wires must be maintained. The total load of all heaters in a circuit must be considered for overload control of that circuit. Power supply must have earth ground.

THESE INSTRUCTIONS SHOULD BE LEFT WITH THE APPLIANCE AND THE USER TO RETAIN FOR FUTURE REFERENCE.

READ THESE INSTRUCTIONS THOROUGHLY BEFORE INSTALLING, USING OR SERVICING THIS EQUIPMENT.

QuadRadiant®

LOW PRESSURE 80,000 BTU Heater

Direct Spark Ignition

LP Gas 10" WC at outlet of control (10 $\frac{1}{4}$ " Max.)

Natural Gas 5 $\frac{1}{2}$ " WC at outlet of control (5 $\frac{3}{4}$ " Max.)

⚠ WARNING:

During normal operation, the surfaces of the unit become very hot. It is VERY IMPORTANT that the power cords and gas supply hoses DO NOT TOUCH OR REST ON ANY surface of the unit or to come within 12" of the heater.

The area directly above the unit becomes hot during normal operation of the heater. DO NOT install electrical wiring, water lines or conduit above the heater. DO NOT run gas supply hoses above the heater.

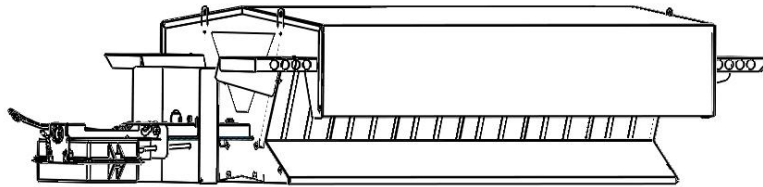

⚠ CAUTION ⚠

DO NOT ALLOW ANYONE WHO HAS NOT READ THESE INSTRUCTIONS TO INSTALL, ASSEMBLE, LIGHT, ADJUST OR OPERATE THIS HEATER. THIS HEATER IS TO BE INSTALLED BY CERTIFIED INSTALLERS ONLY. ONLY PERSONS WHO CAN UNDERSTAND AND FOLLOW THESE INSTRUCTIONS SHOULD USE OR SERVICE THIS HEATER.

HEATER IS SHIPPED PRE-ASSEMBLED

TOOLS REQUIRED FOR INSTALLING HEATER:

$\frac{3}{8}$ " wrench for tightening gas connections

1 $\frac{1}{16}$ " wrench

2 pipe wrenches

$\frac{1}{4}$ " nut driver

| | |
|--|--|
| | <p>! WARNING!</p> <p>Failure to read and understand operator's manual and all safety signs could result in serious injury. Manual must remain with equipment.</p> |
|--|--|



WARNING



**GAS PRESSURE EXCEEDING 10 $\frac{1}{4}$ " WC FOR LP OR 5 $\frac{3}{4}$ " WC FOR NATURAL GAS MAY VOID WARRANTY.
USE THREADED GAS CONNECTIONS ONLY.
HEATER MUST BE CONNECTED TO GAS SUPPLY USING THE DRIP LEG, HOSE AND CONNECTORS PROVIDED WITH THE UNIT BY THE MANUFACTURER.**

CAUTION



Hot Surface
Allow To Cool
Before Servicing

ALLOW HEATING UNIT TO COOL BEFORE WINCHING, CLEANING OR SERVICING.

DO NOT ALLOW GAS HOSES OR POWER CORDS TO TOUCH HOT SURFACE.

DO NOT TOUCH HOT EMITTER PANELS.

CAUTION



CHECK ALL FITTINGS AND CONNECTIONS FOR LEAKS BEFORE USE

BEFORE USING HEATER CHECK ALL FITTINGS AND CONNECTIONS FOR LEAKS.

DO NOT USE OPEN FLAME TO CHECK FOR LEAKS.

USE SOAP AND WATER TO CHECK FOR LEAKS.

CAUTION



Electrical Shock Hazard.
Disconnect Power Supply Before Servicing.

TO AVOID INJURY, ALWAYS DISCONNECT ALL POWER SUPPLY TO THE UNIT BEFORE CLEANING OR SERVICING.

ROUTINE MAINTENANCE IS REQUIRED FOR OPTIMAL HEATER PERFORMANCE AND SAFETY.



THE STATE OF CALIFORNIA REQUIRES THE FOLLOWING WARNING:

WARNING;

Combustion by-products produced when using this product contain carbon monoxide, a chemical known to the State of California to cause cancer and birth defects (or other reproductive harm).



CAUTION:

This appliance is hot during normal operation. Avoid physical contact.



DANGER:

Do not attempt to clean the heater while it is operating or while it is still hot.

QuadRadiant® Heater Installation Checklist

| Installation topics | Checkmark below when complete |
|--|-------------------------------|
| <p>1. Gas Pressure at Heater Q. Have you verified that your gas pressure at the heater is 10$\frac{1}{4}$" WC-LP Gas Maximum or 5$\frac{3}{4}$" WC Natural gas Maximum t outlet of control? A. See page 16 in the installation and operation manual.</p> | |
| <p>2. Gas Hoses and Power Cords Q. Are your gas hoses and power cords positioned properly away from heater? A. See page 9, 10, 15 in the installation and operation manual.</p> | |
| <p>3. Purging the Gas Lines Q. Before attaching the hose, have you purged all gas lines? A. See page 7, 16 in the installation and operation manual.</p> | |
| <p>4. Drip Leg Q. Have you installed a drip leg or sediment trap for each heater? A. See page 7 in the installation and operation manual.</p> | |
| <p>5. Floor and Ceiling Clearance Q. Are your heaters the correct distance from the floor and ceiling? A. See page 11 in the installation and operation manual.</p> | |
| <p>6. Heat Shields Q. Have you installed all the heat shields on all of the heaters? A. See page 11 in the installation and operation manual.</p> | |
| <p>7. Sensor Location Q. Have you positioned your temperature sensor correctly? A. See page 17 in the installation and operation manual.</p> | |
| <p>8. Hanging Q. Are your heaters' hanging points positioned properly, and are all heaters hanging level? A. See page 10, 11, 14 in the installation and operation manual.</p> | |
| <p>9. Air Movement Q. Have you ensured that there will be no direct air blowing on the heaters? A. See page 9, 10 in the installation and operation manual.</p> | |
| <p>10. Cleaning Q. Have you established a cleaning schedule for the heaters and orifices? A. See page 18 in the installation and operation manual.</p> | |

This checklist provides only a limited set up and operational information. Reference the complete installation & operating manual for the QuadRadiant® heater to familiarize yourself with all operational risks and requirements in their entirety. Failure to follow complete installation & operation instructions contained in the product manual(s) shall be considered misuse of the product and could result in personal injury and/or property damage.

Install drip leg on gas line

The manufacturer **requires** the installation of the drip leg in order to help keep the gas orifice free from debris commonly found in gas lines. Use approved and certified sealant on all connections.

WARNING!



Failure to follow the instructions in this manual can result in serious personal injury or property damage.

Horizontal Inlet

— ■ GAS FLOW —▶

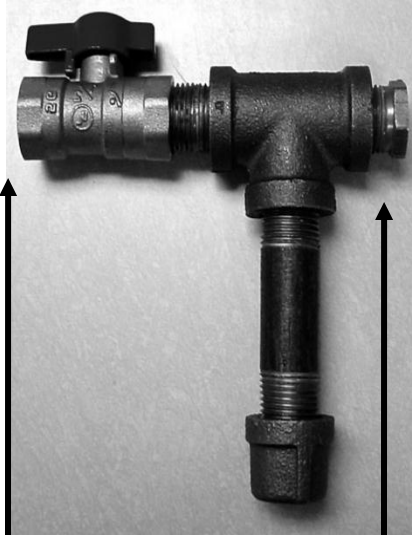

— ■ GAS FLOW —▶

Attach to main gas supply here.

Attach the certified and approved BLACK high pressure gas hose (supplied with unit) here to supply fuel to unit.

— ■ GAS FLOW —▶

Vertical Inlet

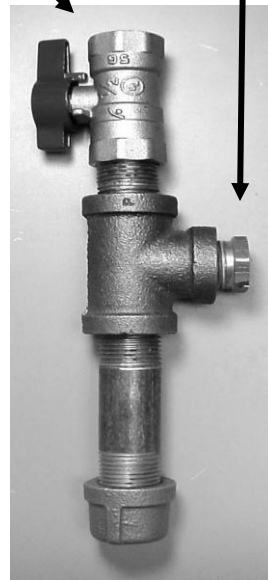

— ■ GAS FLOW —▶

For Component list,
see page 23.



CAUTION: Purge gas supply line of any contaminants before attaching the swivel end of certified and approved BLACK high pressure gas hose assembly (supplied with unit) to valve. Tighten using $\frac{3}{4}$ " and $\frac{11}{16}$ " wrenches.

Control Installation

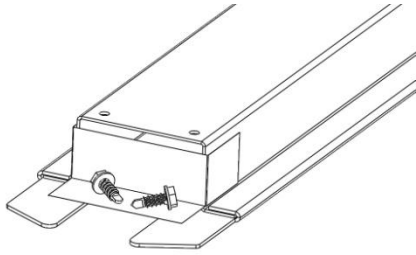

1. Remove tape & bag of screws.

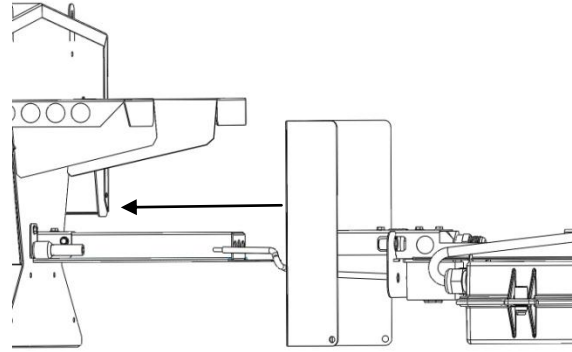

2. Align burner and control.

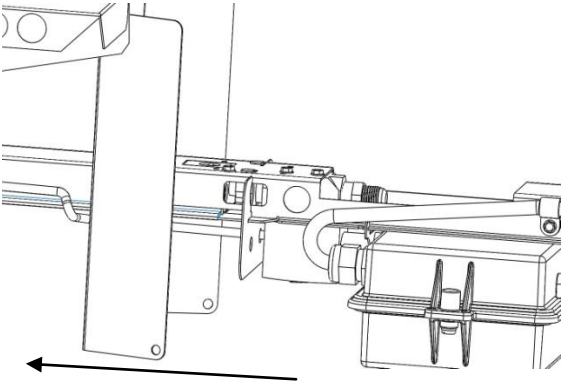

3. Slide control onto burner.

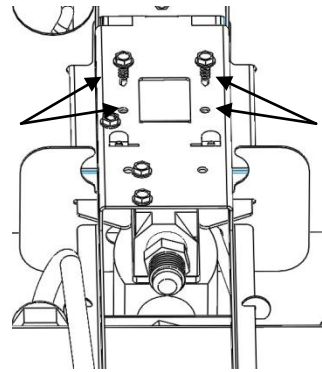

4. Secure with two screws.

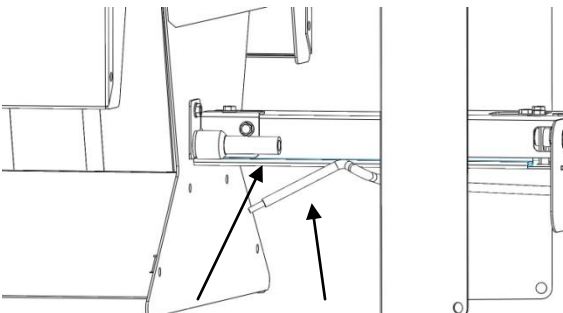

5. Remove boot from igniter.

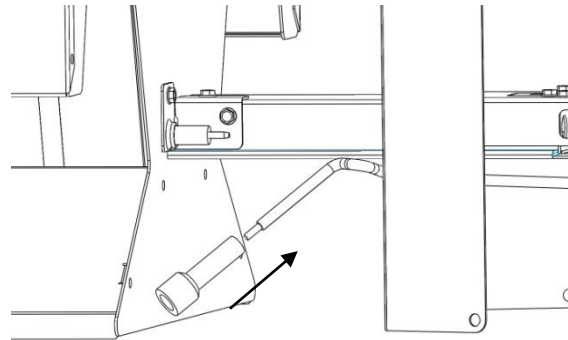

6. Slide boot onto igniter wire.

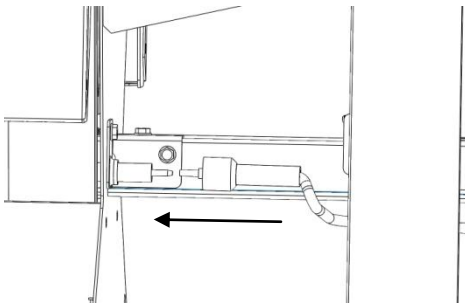

7. Connect wire to igniter.

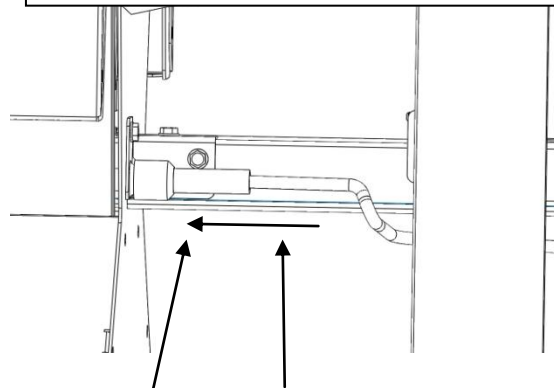

8. Slide boot onto igniter wire.

AIR MOVEMENT

Position heaters so there is no direct air movement on the heater.

Stir fans, inlets and tunnel doors should not blow directly on the units (During minimum ventilation, lock off inlets that affect heater operation).

Check all heaters to be sure flame is not blowing outside the emitter.

Do not run heaters during tunnel ventilation.

Control end of heater should be towards tunnel fan end.

The gas supply inlet must be installed so that the gas supply hose is away from the surface of the heater.
Electrical supply must be installed so that electrical power cord is away from the surface of the unit.

The gas supply hose and the electrical power cord must not touch or rest on any surface of the heater during operation of the unit or rest on the unit while the heater is being winched up or down.

THIS HOSE INSTALLATION IS CORRECT

AIR FLOW

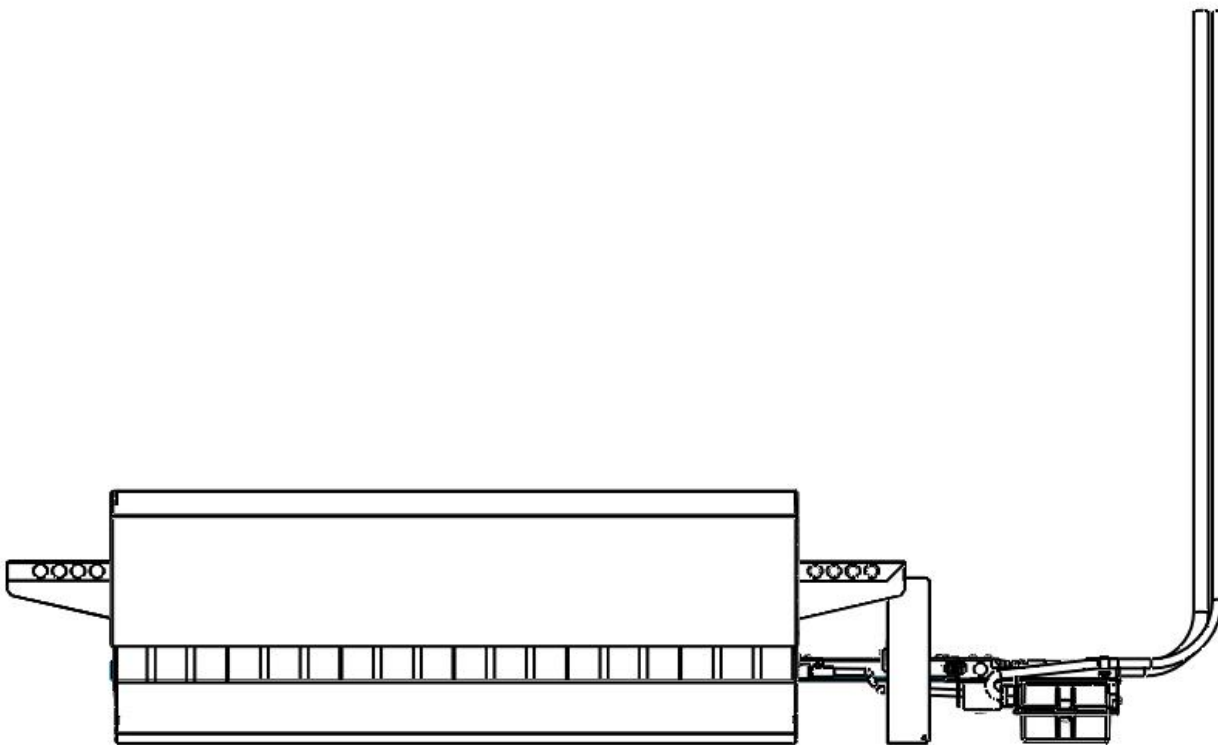

The gas supply installation shown in the illustration above allows the gas supply hose to hang AWAY from the surfaces of the heater even during winching of the unit.

This is the CORRECT method for installing the gas supply hose.

SUSPENDING THE HEATER

NOTE: We recommend that the heater be installed level. Keep gas hose away from hot surfaces.

The heater is attached to a winch cable used for raising and lowering.

In addition, a safety cable or chain (not supplied) is required to be attached to the suspension hooks to prevent the heater from falling to the litter if the cable should happen to break.

HEATER SAFETY CLEARANCE

The heater must be located so there is a minimum clearance to combustible material of 24' (minimum of 12' if the heat deflectors are used) above the heater and 48" from the side.

The heater should be hung with a minimum of 72" from the bottom of the heater and the floor.

We require a minimum clearance of 12" from the heater to the fuel and electricity supply lines.

The installer MUST comply with all applicable local, state, and federal gas codes and regulations.

CAUTION

Always allow heater to cool off before winching unit up to ceiling!
Materials that come in close proximity to hot surfaces may ignite.

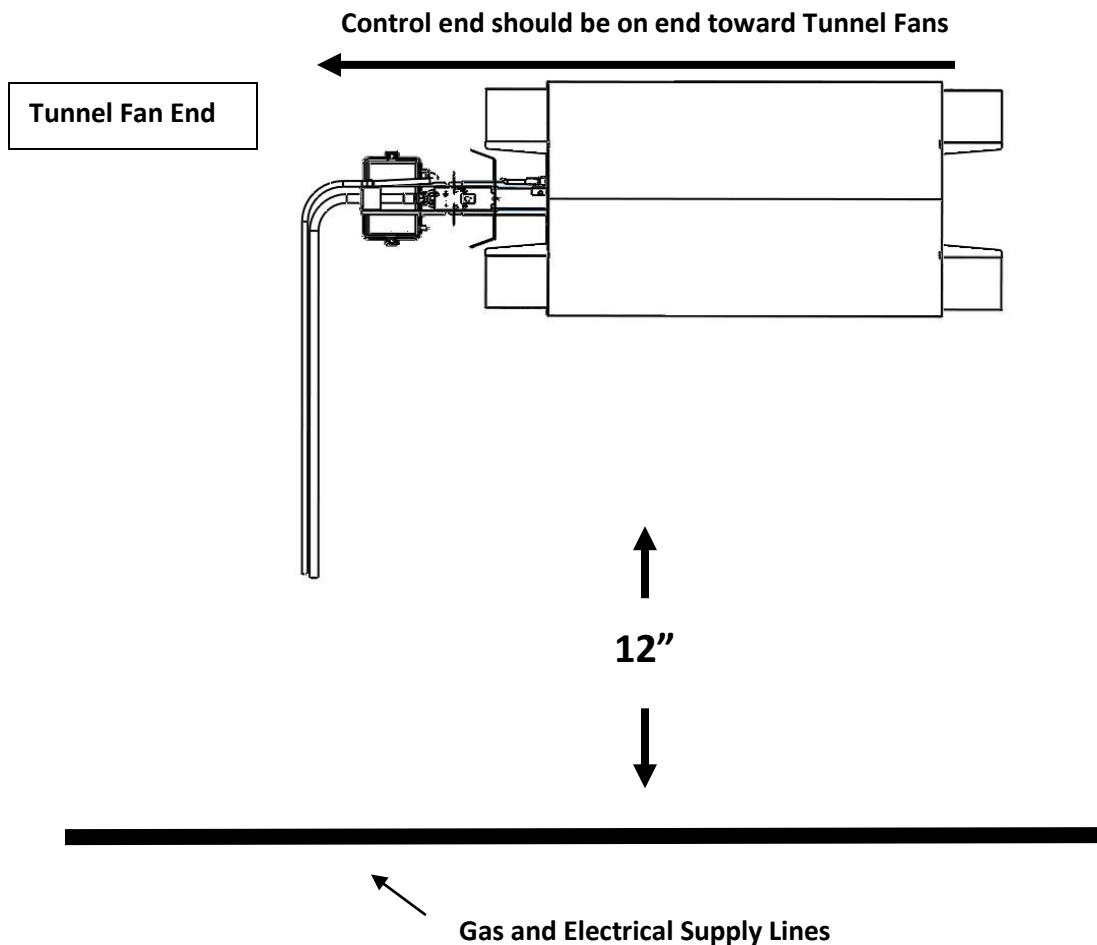

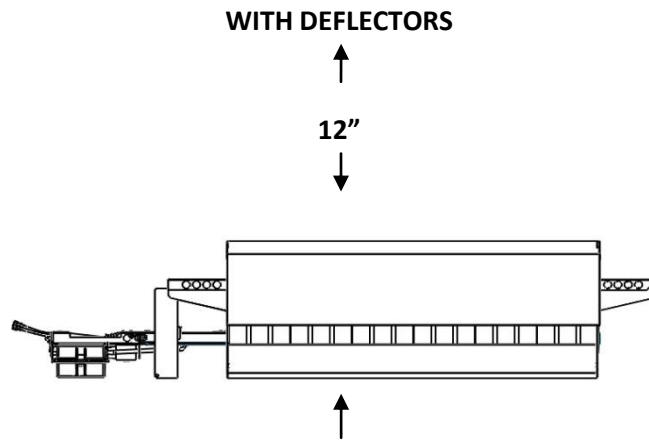

72"

MISSING DEFLECTORS

This is only a temporary adjustment. Heaters REQUIRE the installation of HEAT DEFLECTORS.

↑
24"
↓

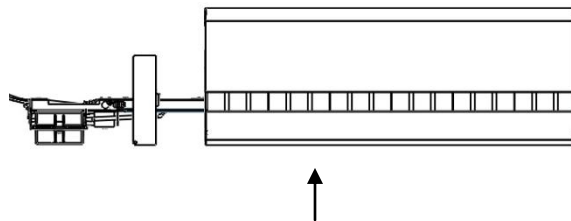

72"
↓

WARNING!

⚠ Do not allow power cords and/or gas supply hoses to rest on the canopy, hanging brackets or other hot surfaces of the unit or within 12" of the heater. Failure to follow these instructions could result in serious personal injury or significant property damage.

WARNING!

⚠ Failure to follow the instructions in this manual could result in serious personal injury or property damage.

WARNING!

⚠ Failure to comply with all applicable local, state, and federal gas codes could result in serious personal injury and/or serious property damage.

Each Unit requires two Left Deflectors and two Right Deflectors.

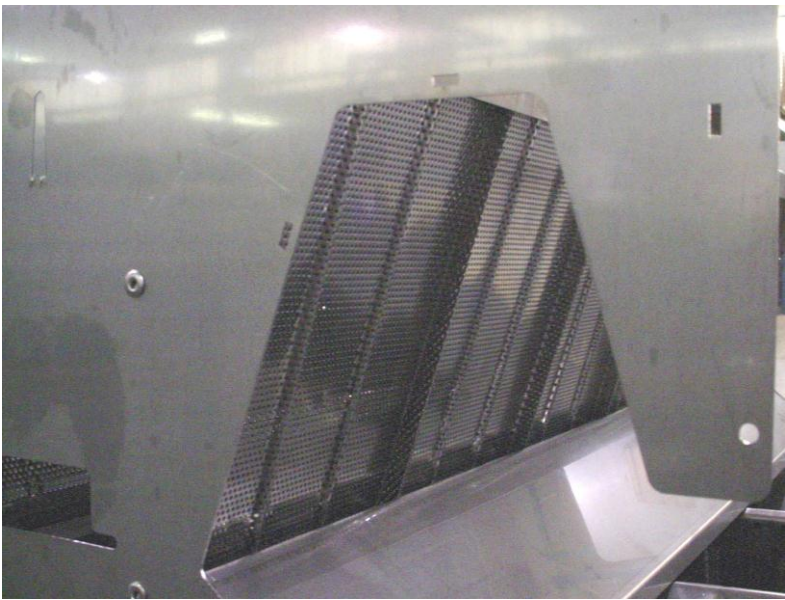
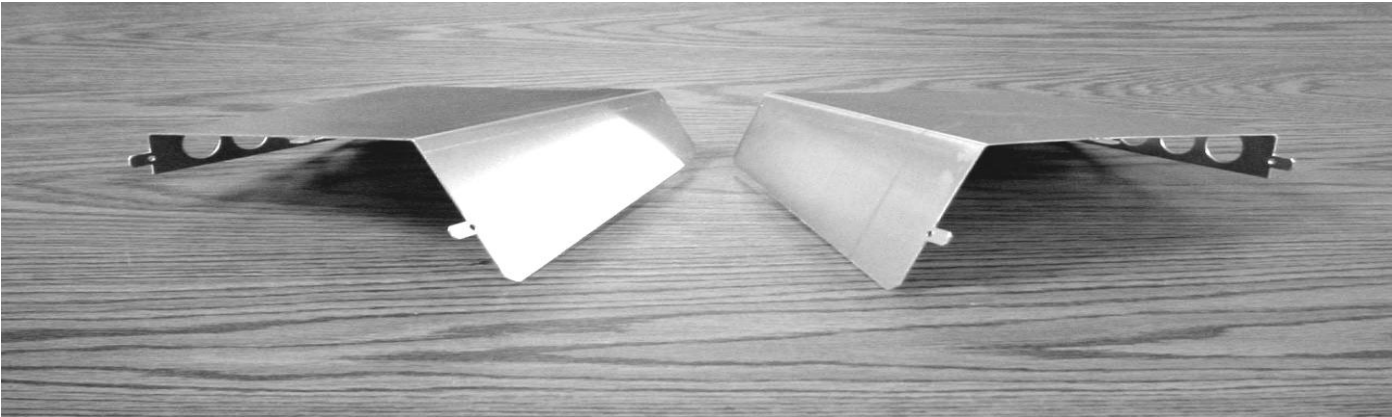

NOTE: Narrow, holed side of the deflectors face toward the outer side of the heater.

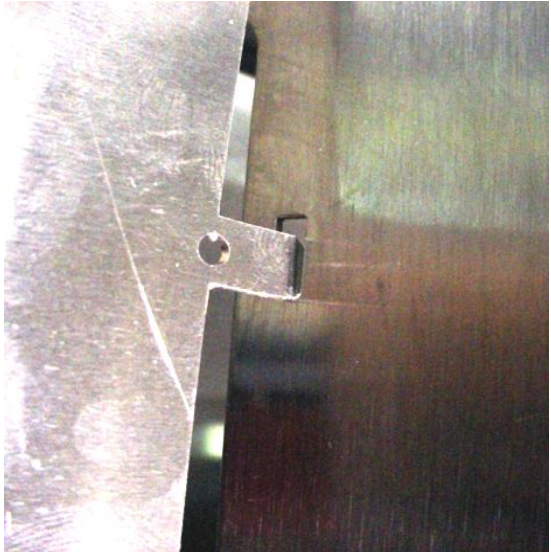

NOTE: Full side of deflectors face to the center of the heater.

Align tabs of deflectors with slots on heater and insert tab into slots completely so that deflectors are flush against unit.

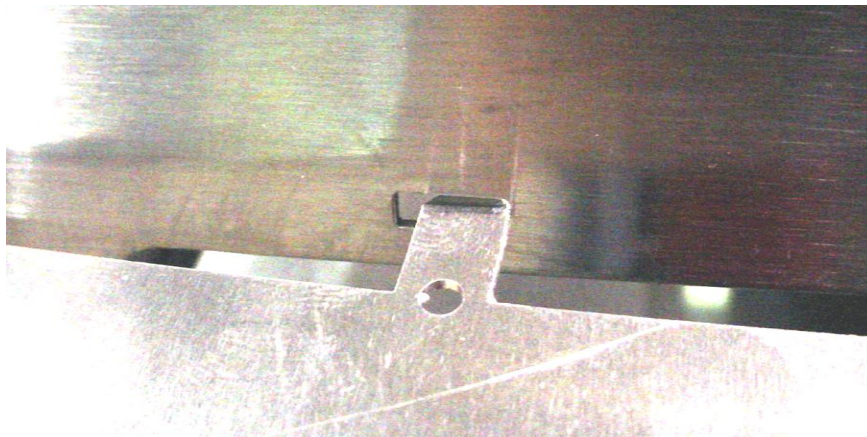

Using pliers, bend the tabs to secure deflectors to the heater.
Bend these tabs toward the outer edge.

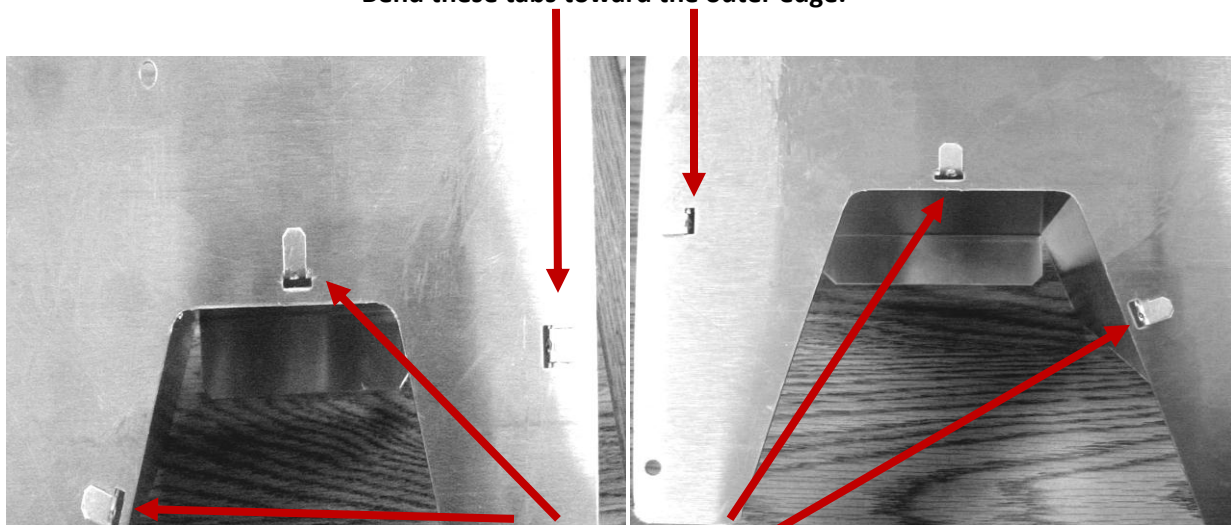

Bend these tabs towards the inside.

Pulley should be mounted in the ceiling and positioned 6" wider than the suspension points in the heater.

Cable
Suspension

Chain and Carabiner
Suspension

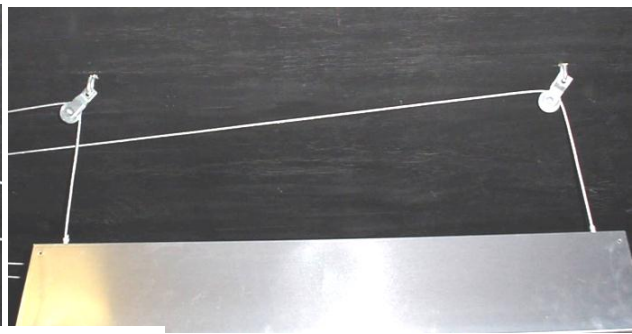
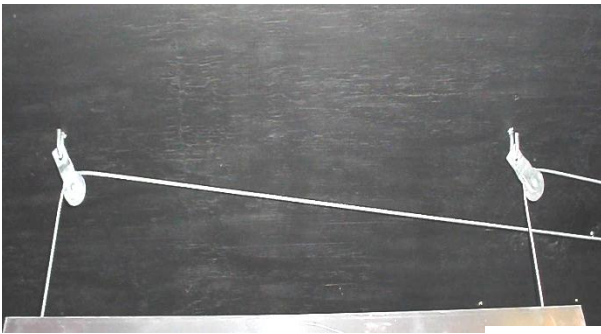

Cable Suspension

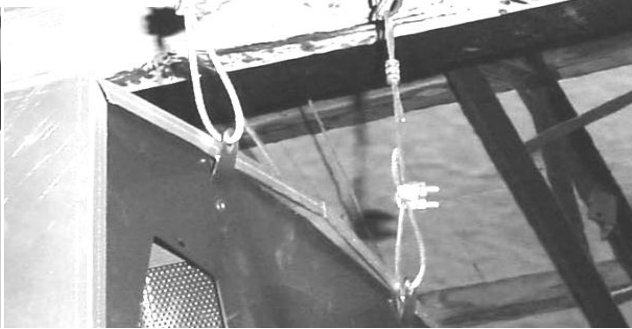

Chain and Carabiner Suspension



NOTE: Do not mount this heater directly below electrical wiring that is exposed or in conduit.

NOTE: During and after winching, make certain that ALL hoses and power supply cords are NOT resting on the heater nor are within 12" of the heater.

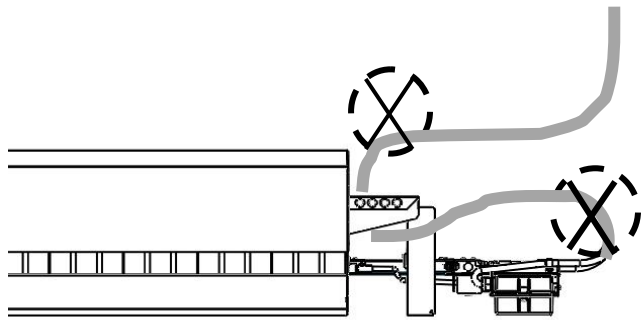

THIS HOSE INSTALATION IS WRONG!

The gas supply hose is touching the heater.

More of the hose will rest on the heater during winching.

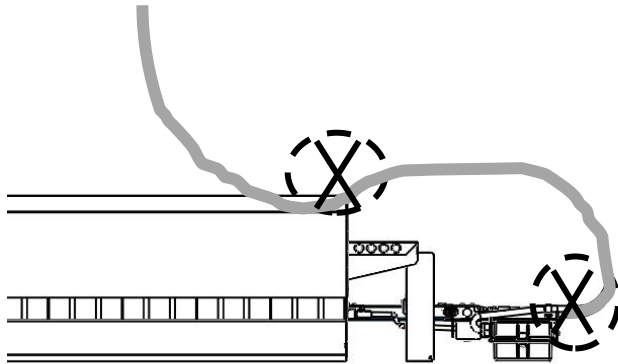

THIS HOSE INSTALATION IS WRONG!

The gas supply hose is touching the heater.

More of the hose will rest on the heater during winching.

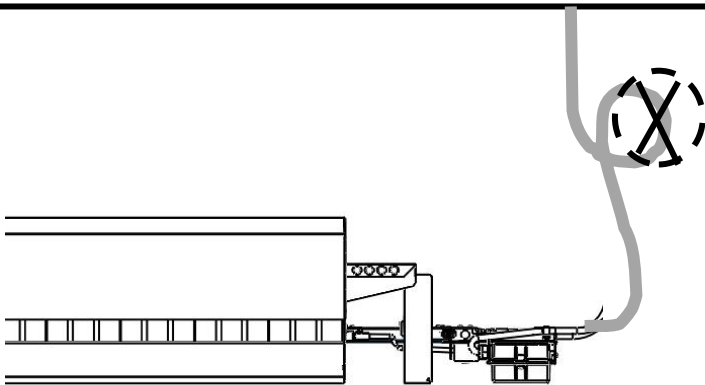

THIS HOSE INSTALATION IS WRONG!

The gas supply hose will rest on the heater during winching

CHECK ALL GAS PIPING AND CONNECTIONS FOR LEAKS BEFORE OPERATING HEATER

It is recommended that the regulator be sized to 30% of the load being supplied.

Gas layout and pipe sizing guidelines are available through your distributor.

GAS PRESSURE should be **CHECKED AND ADJUSTED** to recommended settings.

Pressure exceeding 10 $\frac{1}{4}$ " WC (LP) or 5 $\frac{3}{4}$ " WC (Nat) could void warranty.



CAUTION: Purge gas supply line of any contaminants, and clean any oils and/or contaminants from the inside of the hose before attaching the swivel end of certified and approved BLACK high pressure gas hose assembly (supplied with unit) to valve. Tighten using $\frac{3}{4}$ " and 11/16" wrenches.



Turn on gas supply to the unit and **CHECK ALL FITTINGS AND CONNECTIONS FOR LEAKS** with soapy water solution or leak test solution. Rinse with water after testing unless the leak test solution is noncorrosive. Do Not Use an open flame to check for gas leaks.

To check gas pressure:

FIRST – Go to the furthest heater from the regulator and connect the pressure gauge to the Pressure Tap on the side of the control. (See below) Turn "ON" only the heater you are testing or if you have a zone system, turn "ON" all the heaters in the zone. Set the pressure at a Maximum of 10 $\frac{1}{4}$ " WC (LP gas) or 5 $\frac{3}{4}$ " WC (NAT gas).

SECOND – Turn "ON" all stoves in the house on the same regulator and check the pressure again. The pressure should not drop below 9 $\frac{1}{2}$ " WC (LP gas) or 5 $\frac{3}{4}$ " WC (NAT gas). **If the pressure falls below that shown, the distribution system is inadequately designed. The problem may be a regulator (size or quantity), pipe sizing or other restrictions in the system.**

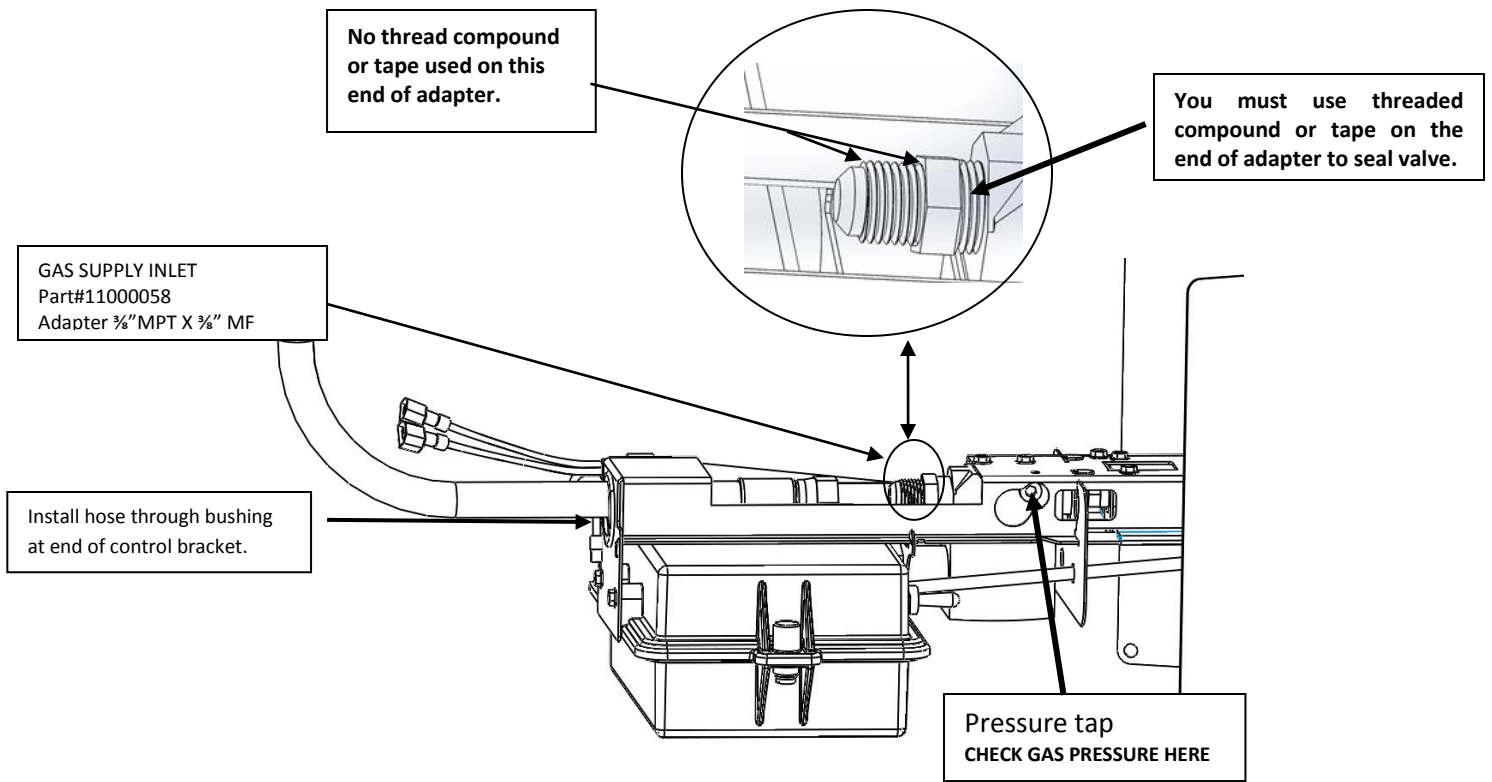

WIRING INSTRUCTIONS FOR 24 VOLT ZONE HEATERS

1. Mount Power Supply in convenient location near electrical panel WITHIN 3 FEET OF OUTLET. Outlet should be separately fused – 15 AMP.
2. Mount junction box over each thermostat location selected.
3. Run 14-2 romex from connections on Power Supply to nearest junction box and continue on the other junction boxes (if used).
4. Run 14-2 romex over each line of brooders to be hooked up to Zone Control. Lines should be run adjacent the gas line. **If more than one thermostat (zones) is to be used – black wire should be cut between zones.**
5. Cut outer insulation ONLY on romex over each brooder to expose black and white wires. **DO NOT OR STRIP WIRES.** Bare ground wires in not used.
6. Using “T” tap connectors connect wire from brooder valve (24V) to romex—white to white; black to black. Note—cut off excess wire from valve.
7. Connect together in junction box using wire nuts:
 - a. Black from Power Supply, Black to next junction box (if used), Black from thermostat.
 - b. White from Power Supply, White to next junction box (if used), White from line over brooders.
 - c. White from thermostat to black from line over brooders.
8. Light brooders in usual manner and set ZONE thermostat for desired temperature.
9. Check for voltage drops to brooder.

(See Wiring Diagram on Pg. 23)

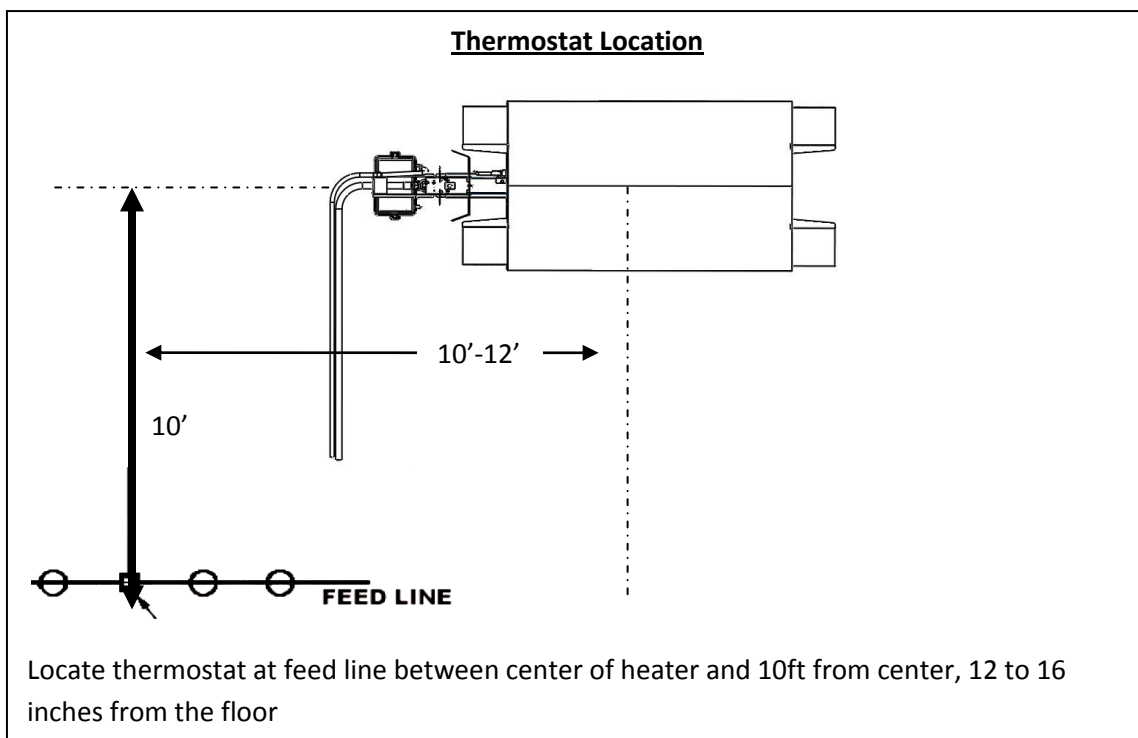

CAUTION



MAINTENANCE

Proper care and maintenance of your heater cannot be over emphasized!!

A POORLY MAINTAINED HEATER WILL:

- Raise Operating Cost – due to poor combustion
- Lower Air Quality
- Cause Inconsistent Temperatures
- Decrease the Life of the Heater



BEFORE PERFORMING ANY MAINTENANCE ON THE HEATER,

MAKE CERTAIN THAT ALL POWER AND FUEL HAS BEEN SHUT OFF TO THE UNIT.

- Daily: Check burner, flames should be burning clear and blue; if not, clean as required or check gas pressure.
- Clean heater after each flock.
Clean orifice with soft brush and blow out with compressed air. **Do Not** clean the orifice with a wire or drill because it will increase orifice hole and result in over firing the emitter.
- BURNER: Run the Bottle Brush in and out of the burner air intake openings located next to the orifice at the outlet of the control valve. Clean off burner ports with Bottle brush.
- EMITTERS: Clean the back and front of the emitters using the Small Wire Brush and the Bottle Brush from the underside and inside the unit.
- CANOPY AND REFLECTORS: Compressed air can be used to clean dust and dirt from canopy, reflector pan, emitters and burner ports. Blow out the inside of the burner assembly using compressed air. Bottle Brush and small Wire brush can also be used to clean the top of canopy, reflector pan and the catch pan under the burner.
- BLOW OUT AND OFF the burner and complete unit with a leaf blower or compressed air after loosening the dust.
- **FOR WASH DOWN APPROVED MODELS ONLY!**
- **POWER WASH DOWN INSTRUCTIONS:**
- MAXIMUM WATER PRESSURE: 2,600 PSI @ 2.3 gpm nozzle: Fan Type – minimum 25 degree.
- DISTANCE FROM NOZZLE TO PARTS: 12 to 18 inches.
- TURN OFF GAS SUPPLY AND DISCONNECT ELECTRICAL POWER. WAIT FOR HEATER TO COOL BEFORE CLEANING. Follow Safety Instructions to power wash equipment.
- 1. Wash down complete heater while keeping the nozzle moving and **NO CLOSER THAN 12"** from any part of the heater.
- 2. After washing heater, raise the end opposite the control to empty the burner of water from wash down. Allow 1 hour for heater to dry before lighting.
- Check ignitor and burner ports for debris; wipe clean with steel wool and clear burner ports with wire.
- If heater is disconnected from the gas line, use tape to seal the open connections. This will keep moisture, dust, and insects out and prevent future problems.
- INSPECT THE HOSE AND POWER CORD for any damage and safe clearance to heater, if damage is detected, replace damaged parts before operating the heater. **DO NOT ALLOW A HOSE AND/ OR A POWER CORD TO TOUCH OR REST ON ANY SURFACE OF THE HEATER OR TO COME WITHIN 12" OF ANY PART OF THE HEATER.**
- **TURN GAS SUPPLY AND ELECTRICAL POWER BACK ON. LIGHT AND CHECK THE HEATER FOR PROPER OPERATION.**



WARNING! Never spray penetrating oil (WD-40) on the control valve. This will cause the loss of high temperature valve grease and cause valve to leak.

Failure to follow these instructions could result in serious personal injury or significant property damage.

24V DUST-TIGHT XTD CONTROL ASSEMBLIES

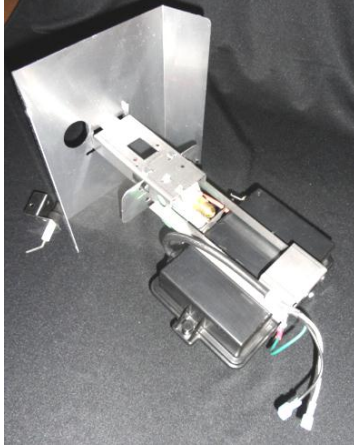

16550447 ASY, XTD CTL DT 24V DSI LP
 16550448 ASY, XTD CTL DT 24V DSI LP HA
 16550449 ASY, XTD CTL DT 24V DSI NAT
 16550450 ASY, XTD CTL DT 24V DSI NAT HA
 16550451 ASY, XTD CTL DT 24 V DSI B/P
 16550452 ASY, XTD CTL DT 24V DSI B/P HA



165050126 IGNITION CONTROL BOX TOP
 1 each

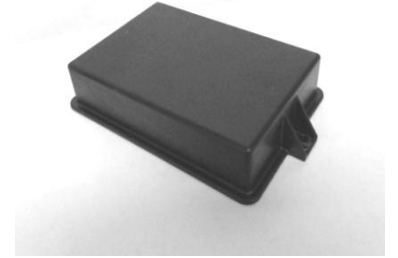

16050127 CONTROL BOX BOTTOM
 1 each

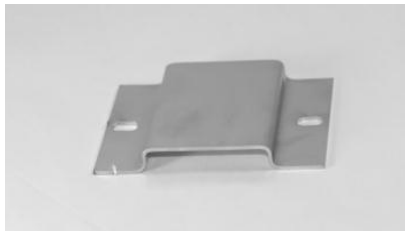

16550086
 SPACER, BURNER/INNER CONE-SHORT
 2 each

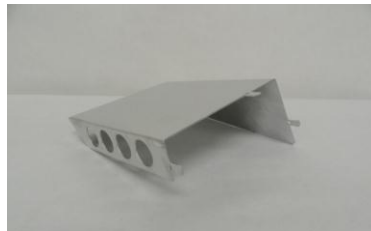

16550038
 HEAT DEFLECTOR LEFT
 2 each

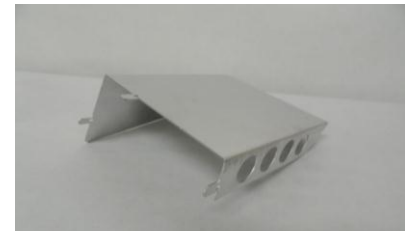

16550037
 HEAT DEFLECTOR RIGHT
 2 each

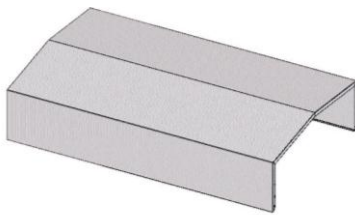

16550015 CANOPY
 1 each

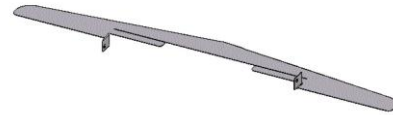

16550081 CENTER SUPPORT CANOPY
 1 each

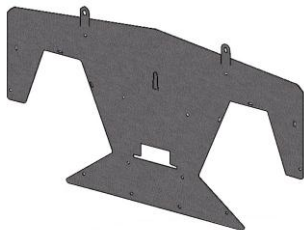

16550080 END PLATE CONTROL END
 1 each

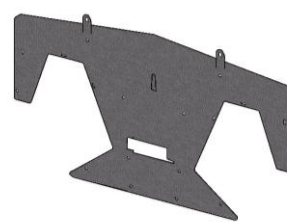

16550079 END PLATE OPPOSITE CONTROL
 END
 1 each



16550085
PAN/CHANNEL REFLECTOR
2 each

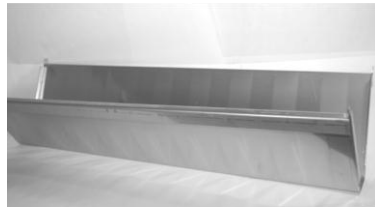

16550089
CORRUGATED INNER CONE
1 each



16550082
BOTTOM FLAME SHIELD
1 each



16550084
EMITTER PANEL
12 each

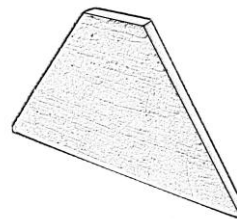

16050048
INSULATION, END PANEL
2 each

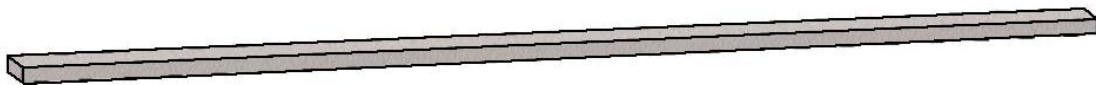

16050046 INSULATION, BOTTOM PANE 1 each

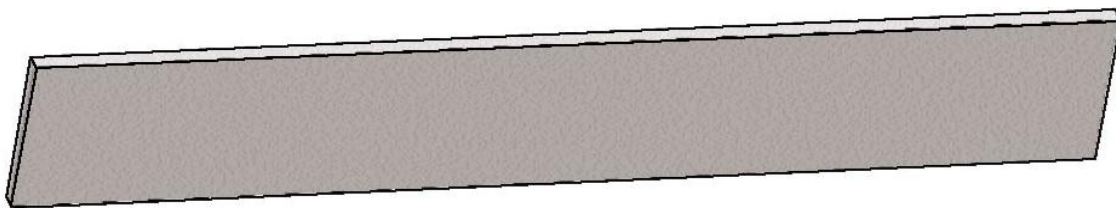

16050047 INSULATION, SIDE PANEL 2 each

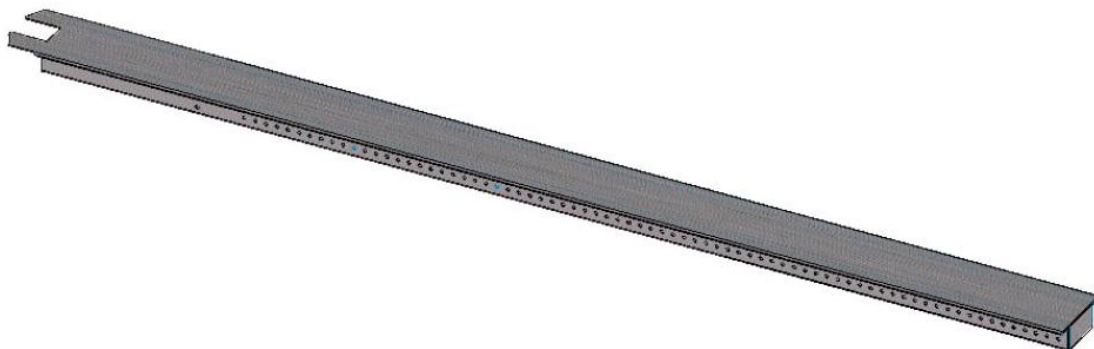

16550093 BURNER ASSEMBLY 1 each



13005282 SWITCH TOGGLE
SINGLE POLE 1

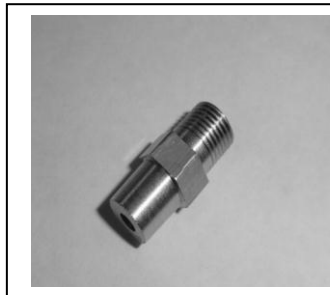

- 16050131 ORIFICE #24 (NAT)
- 16050132 ORIFICE #27 (NAT/ HA)
- 1650158 ORIFICE #37 (LP)
- 16050160 ORIFICE #39(LP/HA)
- 16050159 ORIFICE #38 (B/P)
- 16050161 ORIFICE #41 (B/P- HA)



11000058
ADAPTER
3/8" MPT X
3/8" MF
1 EACH



11000034 NYLON WIRE
CLAMP 1 each



16550438 COIL SHIELD 1each



16550135 IGNITOR w/BURNER
MOUNT AND WIRE 1 each



16550473 WIRES ASSY, LoPRESS WSHBX

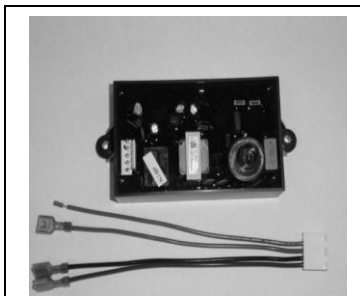

16550248 IGNITION MODULE AND
IGNITION WIRE HARNESS KIT 24V



16550325 VALVE ASSY 24V
W/BRKT, STRAIN RELIEF



16550436 PLASTIC BOX SHIELD
1 each



16-13109150 HOG-RING
2 each



16-11194 BUSHING: GALVD STD HEX
3/8" X 3/4" 1 each



10106615 HEYCO STRAIN RELIEF
SR7K-2 1 each

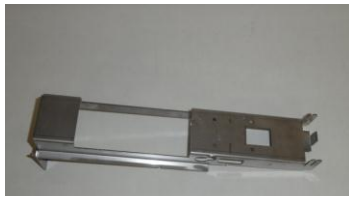

16550439 CONTROL BOX BRACKET
1 each

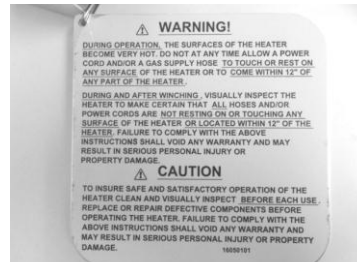

16550223 HANG TAG WITH CLEANING
LABEL 1 each

PARTS NOT SHOWN IN ILLUSTRATION

| | | |
|-------------|------------------------------|----|
| 16050021 | RIVET: POP 3/16" SS SSD | 26 |
| 13005235 | TECK SCREW 8 X 1/2 | 4 |
| 16000149 | SCREW 8-32 X 3/8 HWS TYPE 23 | 4 |
| 16-27020750 | SCREW TYPE F HWS 8/32 X 1/2 | 2 |

PARTS FOR WASHDOWN QUADRADIANT® HEATER



13008107 STRAIN RELIEF
1 each



16550323 ENCLOSED DRILLED
IGNITION CONTROL BOX PLASTIC BOX
TOP WITH GASKET 1 each



16000047
RUBBER BOOT FOR
TOGGLE SWITCH
1 each

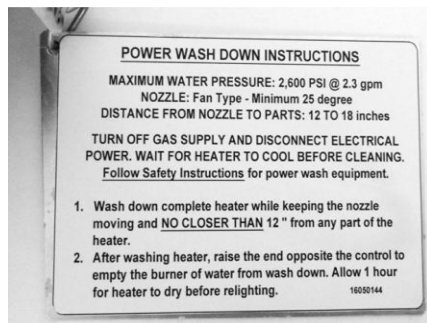

16550301 HANG TAG, WASH DOWN INSTRUCTIONS
1 each

24V XTD WASH-DOWN-PROOF
CONTROL ASSEMBLIES

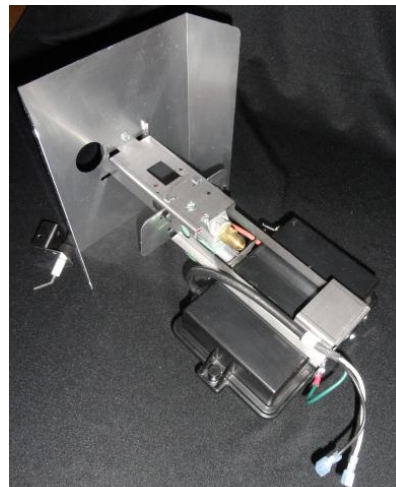

- 16550459 ASY, CTL XTD WDP 24V DSI LP
- 16550460 ASY, CTL XTD WDP 24V DSI LP HA
- 16550461 ASY, CTL XTD WDP 24V DSI NAT
- 16550462 ASY, CTL XTD WDP 24V DSI NAT HA
- 16550463 ASY, CTL XTD WDP 24 V DSI B/P
- 16550464 ASY, CTL XTD WDP 24V DSI B/P HA

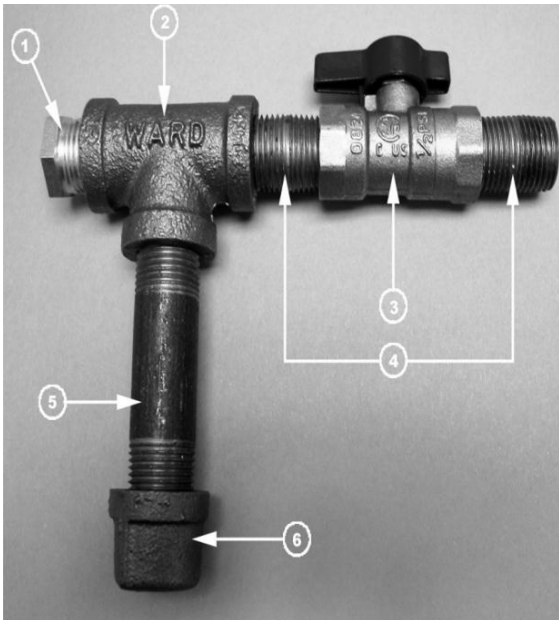

16050208

DRIP LEG

- | | | |
|----|---------------------------------|---|
| 1. | 13005255 PIPE TEE ½" X ½" X 1"/ | 1 |
| 2. | 13004937 VALVE ½" BRASS VALL | 1 |
| 3. | 13005228 PIPE NPL ½" CLOSE BLK | 2 |
| 4. | 13005193 PIPE NPL ½" X 3" BLK | 1 |
| 5. | 13005229 PIPE CAP ½" BLK | 1 |

24V WIRE DIAGRAM

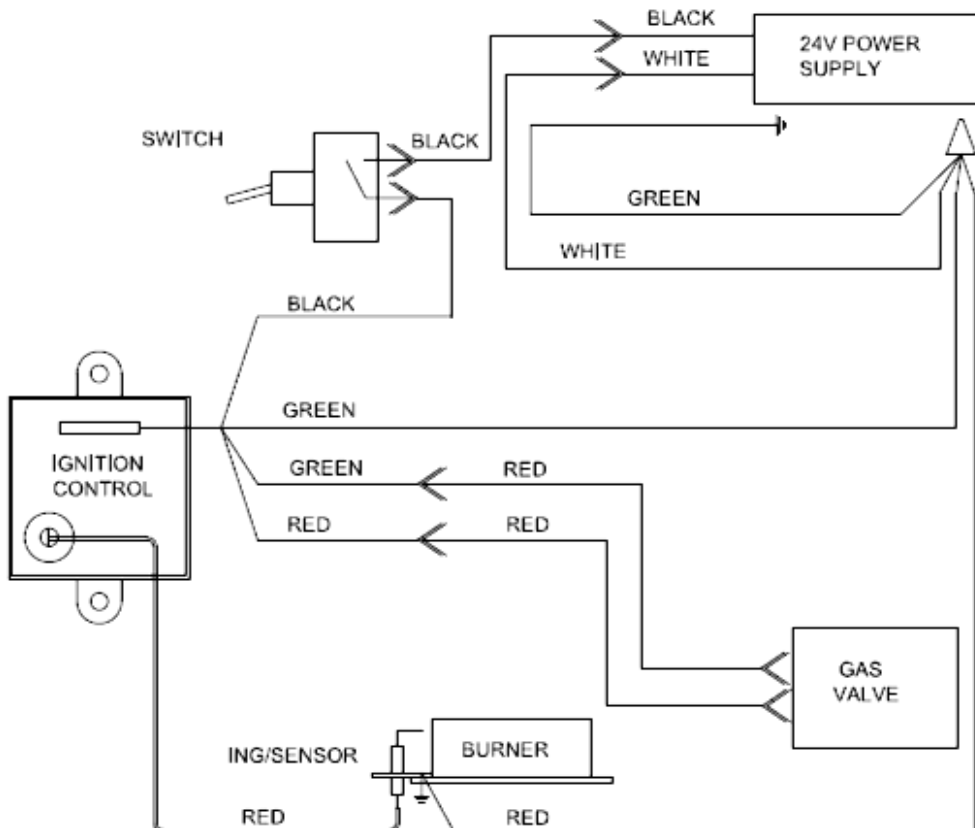

24 Volt Wiring Diagram for 120V or 240V AC Power Supply

240 V Transformer runs up to 25 Brooders

