

CHORE-TIME[®]

Broadcaster Installation and Operators Instruction Manual



Contact your nearby Chore-Time distributor or representative for additional parts and information.

CTB, Inc.
PO Box 2000
Milford, Indiana 46542-2000 USA
Phone (574) 658-4101
Email: choretime@choretime.com
Internet: www.choretime.com

Warranty

LIMITED WARRANTY ("Warranty")

Chore-Time Group, a division of CTB, Inc. ("Chore-Time") warrants new BROADCASTER® systems ("Product") manufactured by Chore-Time to be free from defects in material or workmanship under normal usage and conditions, for One (1) year from the date of purchase by the original purchaser ("Purchaser"). If such a defect is determined by Chore-Time to exist within the warranty period, the exclusive remedy will be to repair or replace the Product at the sole discretion of Chore-Time, at no charge to the Purchaser. Labor costs associated with the removal and/or installation of replacement and/or repaired Product, as well as freight costs, are not covered by this Limited Warranty. This Warranty is not transferable, and applies only to the Purchaser.

THIS WARRANTY CONSTITUTES CHORE-TIME'S ENTIRE AND SOLE WARRANTY AND CHORE-TIME EXPRESSLY DISCLAIMS ANY AND ALL OTHER WARRANTIES, INCLUDING, BUT NOT LIMITED TO, EXPRESS AND IMPLIED WARRANTIES, INCLUDING, WITHOUT LIMITATION, WARRANTIES AS TO MERCHANTABILITY OR FITNESS FOR PARTICULAR PURPOSES. Chore-Time shall not be liable for any direct, indirect, incidental, consequential or special damages which any Purchaser may suffer or claim to suffer as a result of any defect in the Product. Consequential or Special Damages as used herein include, but are not limited to, lost or damaged products or goods, costs of transportation, lost sales, lost orders, lost income, increased overhead, labor and incidental costs, and operational inefficiencies. Some jurisdictions prohibit limitations on implied warranties and/or the exclusion or limitation of such damages, so these limitations and exclusions may not apply to you. This Limited Warranty gives the Purchaser specific legal rights. You may also have other rights based upon your specific jurisdiction.

The following circumstances will render this Warranty void:

- Modifications made to the Product not specifically delineated in the Product manual.
- Product not installed, tested, and/or operated in accordance with the instructions published by the Chore-Time.
- All components of the Product are not original equipment supplied by Chore-Time.
- Product was not purchased from a Chore-Time authorized distributor or certified representative.
- Product was not installed by a Chore-Time authorized distributor or representative, or a licensed electrician.
- Product experienced malfunction or failure resulting from misuse, abuse, mismanagement, negligence, alteration, accident, or lack of proper maintenance, or from lightning strikes, electrical power surges or interruption of electricity.
- Product experienced corrosion, material deterioration and/or equipment malfunction caused by or consistent with the application of chemicals, minerals, sediments or other foreign elements.
- Product was used for any purpose other than for the care of poultry and livestock.
- Product malfunction or failure due to insufficient telephone, wireless, broadband, and/or cellular quality or service, or due to other equipment connected to the same landline and/or cellular modem line.

This Limited Warranty may only be modified in writing by an officer of Chore-Time. Chore-Time will have no obligation or responsibility for any representations or warranties made by or on behalf of any distributor, dealer, agent or certified representative.

DISCLAIMER OF LIABILITY

Compliance with federal, state and local rules which apply to the location, installation and use of the Product are the responsibility of the Purchaser. Chore-Time will not be liable for any damages which result from non-compliance with such rules.

Chore-Time does not represent nor warrant that the Product will prevent any loss, damage or injury to person or property, or that the Product will in all cases provide the protection for which it is installed or intended. Purchaser acknowledges that Chore-Time is not an insurer, and that Purchaser assumes all risk for loss or injury.

Purchaser acknowledges that signals which are transmitted over the landlines or cellular modem lines or other modes of communication pass through communication networks wholly beyond the control of Chore-Time, and are not maintained by Chore-Time, and, therefore, Chore-Time will not be responsible for any Product or communication failure which prevents transmission signals from reaching the intended telephone numbers.

Effective: **April 2017**

Contents

Topic	Page
Warranty	2
Safety and General Information	5
Follow Safety Instructions	5
Decal Descriptions	5
DANGER: Moving Parts	5
DANGER: Electrical Hazard	5
General Information	6
Introduction	6
Broadcaster™ Features	6
Connection to Chore-Tronics® 3 Control	6
Getting Familiar with the Control	7
Control Navigation	7
Navigation Arrow Buttons	7
Enter Button	7
Alphanumeric Keypad	8
Installation	9
Mounting the Control	9
Broadcaster Setup	9
Disarming the Broadcaster	9
Method 1	9
Method 2	9
Arming the Broadcaster	9
Saving the Current Installed Modems	10
Cellular Modem Setup	10
Checking Cell Signal	10
Land Line Modem Setup	11
General Settings Menu	11
Setting Date and Time	11
Setting Clock Format	11
Main Box Setup	12
Base Box Type	12
Box Name	12
Alert Delay	12
Alert Suspend Time	13
Alert Digital Inputs Naming	13
Dialing	14
Landline Dialing	14
Cellular Dialing	14
SMS Text Messaging	15
Server Voice and Texting Dialing	16
Alert Notify List	16
Acknowledgment Code	17
Network Setup	18
LAN Network	18
History	22
View History	22
Copy History	22
Auxiliary Box Setup	23
Box Type (Auxiliary)	23

Contents - continued

Topic	Page
Time and Date (Auxiliary)	23
Auxiliary Box Clock Format	23
Auxiliary Box Names	24
Alert Names (Aux.)	24
Alert Box Network Setup	24
Broadcaster™ Testing	25
Call/Text Testing	25
System Alert Testing	25
Battery Testing	25
Testing Modems	26
Landline Modem Testing	26
Cellular Modem Testing	26
SMS Texting Modem Testing	26
Updating Broadcaster™ Software	27
Hot Keys	27
Operator Panel Hot Key Combinations	27
SMS Text commands	27
Cell Modem Sim Card Installation (GSM/ATT)	28
Wiring	29
Fiber Ethernet (Wiring	29
Wireless Radios (CT3 and other Chore-Tronics Controls) Wiring	30
Ethernet Cat 5e-6 (CT3 and other Chore-Tronics Controls) Wiring	31
CT2 Alarm Relay Kit (50246) Wiring	32
External Alert (Alarm) Wiring	33
Generator Transfer Alert.	34
Broadcaster IO Board's Eight Digital Inputs	35
Parts Listing	36

Safety and General Information

Caution, Warning and Danger Decals have been placed on the equipment to warn of potentially dangerous situations. Care should be taken to keep this information intact and easy to read at all times. Replace missing or damaged safety decals immediately.

Safety–Alert Symbol



This is a safety–alert symbol. When you see this symbol on your equipment, be alert to the potential for personal injury. This equipment is designed to be installed and operated as safely as possible...however, hazards do exist.

Understanding Signal Words

Signal words are used in conjunction with the safety–alert symbol to identify the severity of the warning.



DANGER indicates an imminently hazardous situation which, if not avoided, **WILL** result in death or serious injury.



WARNING indicates a potentially hazardous situation which, if not avoided, **COULD** result in death or serious injury.



CAUTION indicates a hazardous situation which, if not avoided, **MAY** result in minor or moderate injury.

Follow Safety Instructions

Carefully read all safety messages in this manual and on your equipment safety signs. Follow recommended precautions and safe operating practices.

Keep safety signs in good condition. Replace missing or damaged safety signs.

Decal Descriptions

DANGER: Moving Parts

Disconnect electrical power before working on system, equipment may start automatically. Otherwise, personal injury will result.

Severe personal injury will result if the equipment is operated without covers properly installed.

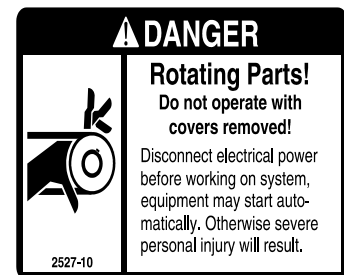

DANGER: Electrical Hazard

Disconnect electrical power before inspecting or servicing equipment unless maintenance instructions specifically state otherwise.

Ground all electrical equipment for safety.

All electrical wiring must be done by a qualified electrician in accordance with local and national electric codes.

Ground all non-current carrying metal parts to guard against electrical shock.

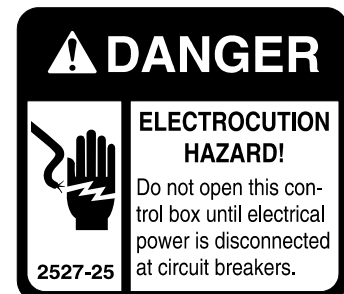

Electrical disconnects and over current protection are not supplied with the equipment.

General Information

The Chore-Time **Broadcaster** is designed to be used to send notifications to Landlines or Mobile devices. Using the equipment for purposes other than specified in this manual may cause personal injury and/or damage to the equipment.

Introduction

Broadcaster™ Features

- Alert system provides notifications to: Landline via voice, Cellphones via voice and Cellphones via text.
- Passes along alert notifications from Chore-Tronics® to user.
- Add and name up to eight alert inputs (subject to system limitations)
- Notify list can be up to 10 numbers
- List can consist of:
 - Voice calls to a landline.
 - Voice calls to a cell phone.
 - SMS (text) message to a cell phone.
- Voice calls can be made on a landline or via the optional cellular modem
- SMS messages are sent via cellular modem only
- The Broadcaster™ notifies each number in the list, in order, until the acknowledgment code is entered.
- If SMS messaging is used, all phones that have been sent a message will be sent an additional message informing which number acknowledged the alert.

Connection to Chore-Tronics® 3 Control

- The Chore-Tronics® 3 Main Control connects to the Broadcaster™ using Ethernet via: Traditional Cat5e cable, Fiber-Optic Cable, and/or Wireless Ethernet Radios.
- Will pass on alerts from the Chore-Tronics 3 to the user.
- A maximum of 20 controls can be connected to the Broadcaster™.
- Broadcaster will alert user if communication is lost between the Chore-Tronics® 3 and the Broadcaster.
- Eight alert inputs are available on the Broadcaster™ Main Box. If more than eight inputs are required, then the optional Auxiliary box is used. Each Auxiliary box will add an additional eight alert inputs.
- Place an Auxiliary box with every house to give eight alert inputs per house!
- Broadcaster™ will alert user if communication is lost between the main box and auxiliary box.

Getting Familiar with the Control

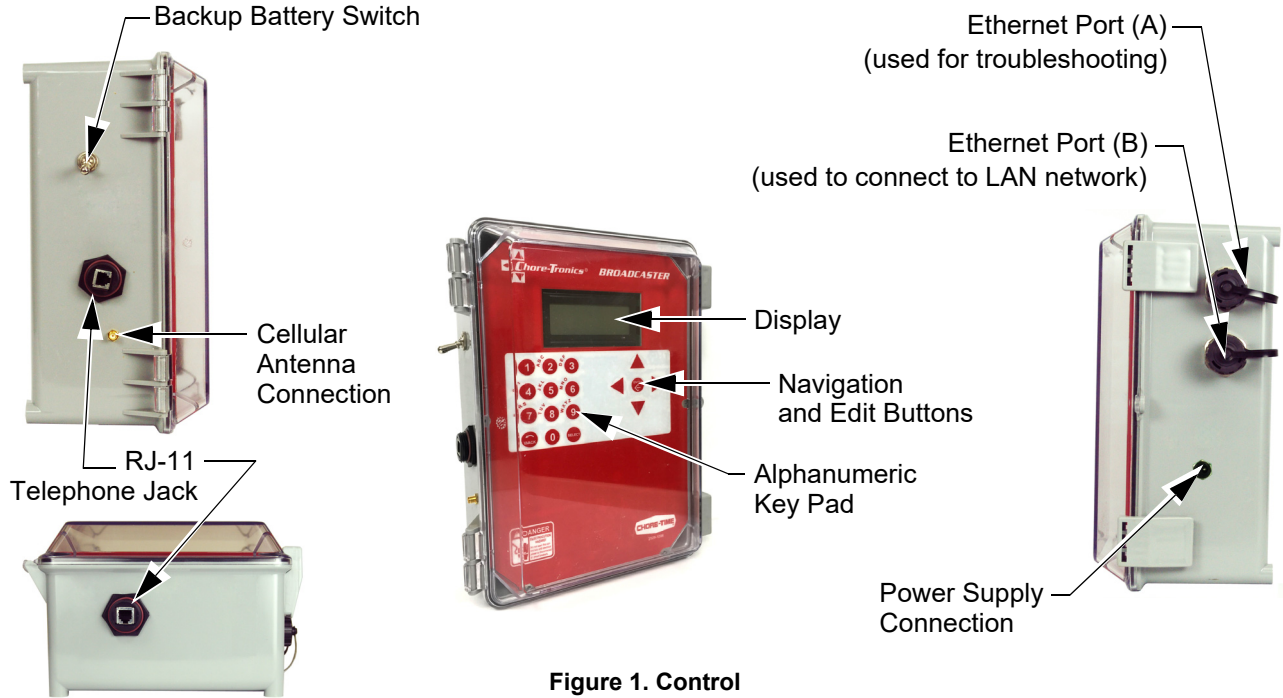

Figure 1. Control

Control Navigation

Navigation Arrow Buttons

These buttons allow you to scroll up and down in long screens and left and right to select the option you want. In some screens, the left and right buttons are used to edit a field.

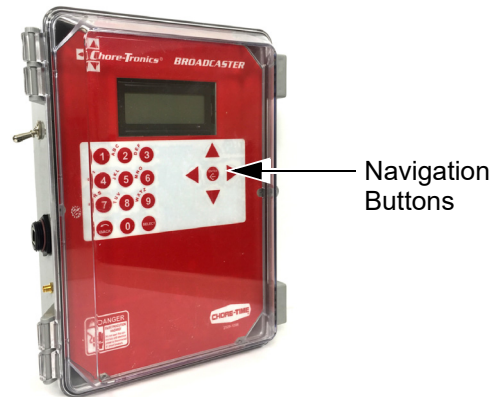
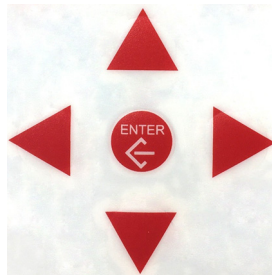

Figure 2. Navigation Buttons

Enter Button

This button is used to select an option and save.

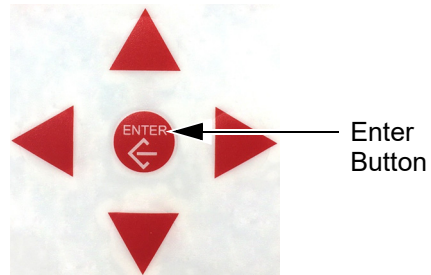

Figure 3. Enter Button

Alphanumeric Keypad

The Alphanumeric Keypad is used to enter a number directly into a field without having to scroll to the number. The Alphanumeric Keypad can also be used to change the name of some text fields. The first letter above each Key is chosen by pushing that Key once. To choose the second letter above each Key, push that Key twice. In our example, the letter B is chosen by pressing the #2 button two times in a row. The letter R is chosen by pressing the #7 button three times in a row.

The Back button is used to return to the previous-viewed screens.

The Select button does the same function as the Enter button.

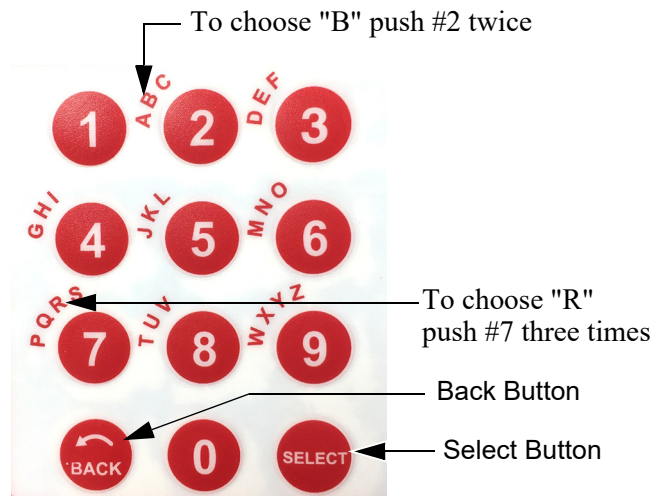

Figure 4. Alphanumeric Buttons

Installation

Mounting the Control

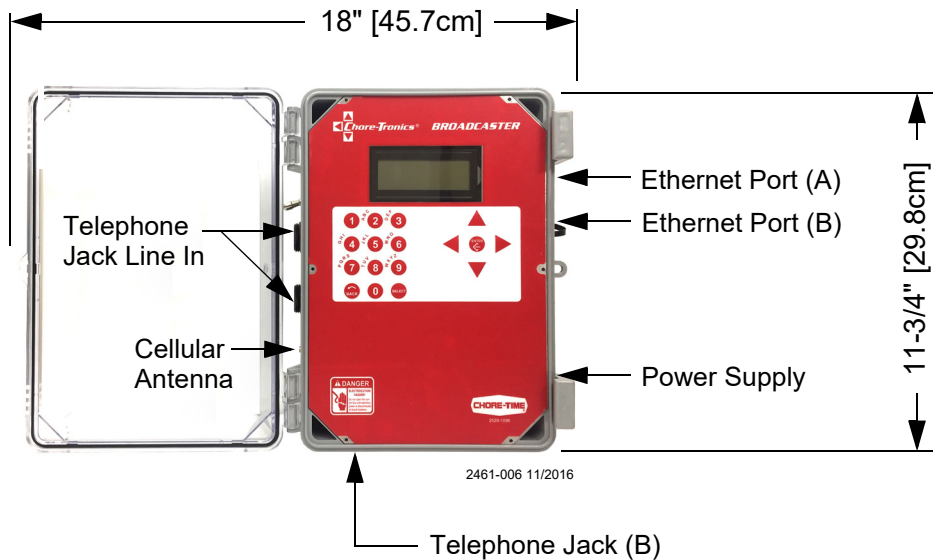

Figure 5. Mounting the Control

Broadcaster Setup

Disarming the Broadcaster

Before Setting up the Broadcaster, it will have to be disarmed. There are two methods to Disarm/Arm the Broadcaster.

Method 1

Press the 3 and 9 button simultaneously and release. The Current Condition Screen displays "Disarmed."

Method 2

1. From the Current Conditions Screen, press the Back Button to enter the Main Menu.
2. Select Alert Actions.
3. Select Arm/Disarm.
4. Press Enter to change the current Status.

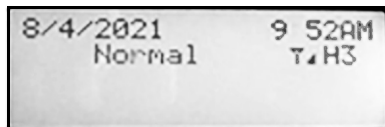

1)

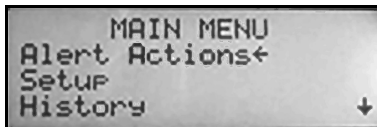

2)

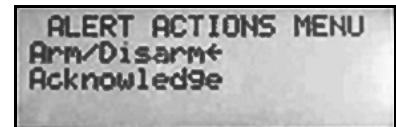

3)

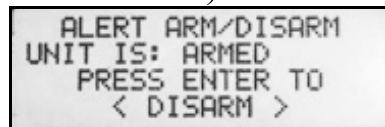

4)

Arming the Broadcaster

1. Arm the Broadcaster after you have completed all the Setup.
2. Test the Modems by sending a Dial Test and sending a test alert from the Controls.
3. Saving the current installed Modems must be done before continuing with the setup of the Broadcaster.

Saving the Current Installed Modems

Cellular Modem Setup

From the Current Conditions screen, press the Back Button.

1. From the Main Menu, select Setup.
2. Select General.
3. From the General Setup menu screen, scroll down and select Cell Modem Config.
4. Select Cell Modem Setup.
5. The current installed Cell Modem displays. If none are installed, you still must save as None.
6. Press Enter to save. Select Yes to confirm.

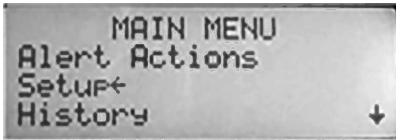

1)

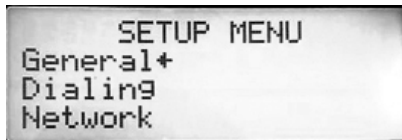

2)

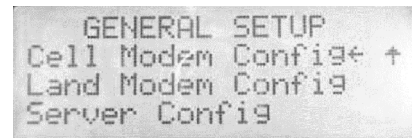

3)

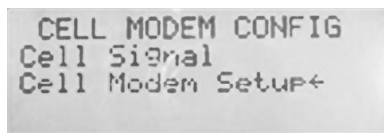

4)



5)

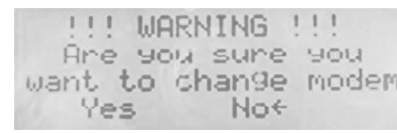

6)

Checking Cell Signal

From the Current Conditions screen, press the Back Button.

1. From the Main Menu, select Setup.
2. Select General.
3. From the General Setup menu screen, scroll down and select Cell Modem Config.
4. Select Cell Signal. The Cellular Signal screen displays.

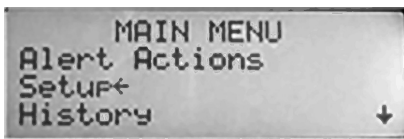

1)

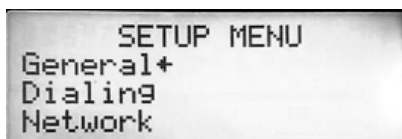

2)

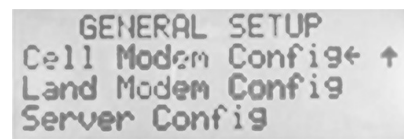

3)

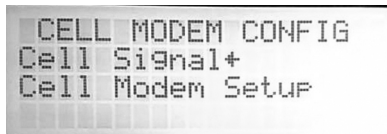

4)

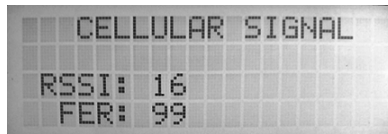

5)

Land Line Modem Setup

From the Current Conditions screen, press the Back Button.

1. From the Main Menu, select Setup.
2. Select General.
3. From the General Setup menu screen, scroll down and select Land Modem Config.
4. Select Land Modem Setup. The current installed Land Modem displays.
5. Press Enter to Save.
6. Select Yes to confirm.

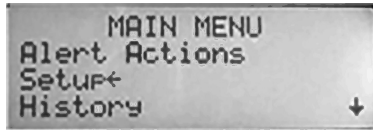

1)

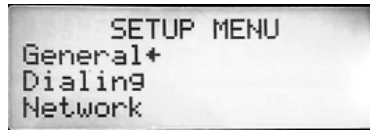

2)

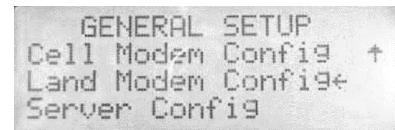

3)



4)



5)

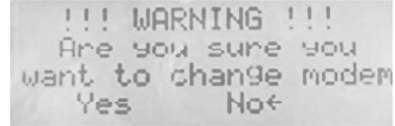

6)

General Settings Menu

Setting Date and Time

1. From Current Conditions screen, press the Back Button to get to the Main Menu.
2. From the Main Menu, select Setup.
3. Select General.
4. Select Time and Date.
5. Select Set Time and Date.
6. Edit the Time and Date with the Arrow Buttons.
7. Press the Enter to save.

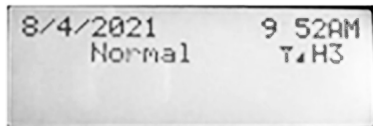

1)

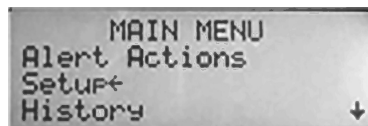

2)



3)



4)

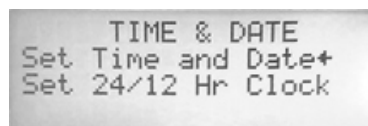

5)

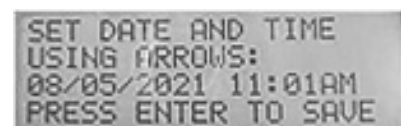

6)

Setting Clock Format

1. From the Time & Date screen, select Set 24/12 Hr. Clock to change the time format.
2. Move the pointer to Yes.
3. Press Enter to change from the current format.

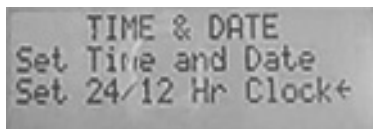

1)

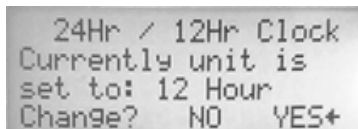

2)

Main Box Setup

Base Box Type

1. From the Setup Menu screen, select General.
2. Select Box Type.
3. Select Base.
4. Press Enter to save. The Broadcaster™ restarts after the BOX TYPE is saved.
5. After the restart, return to General Setup screen to continue with the setup.



1)



2)

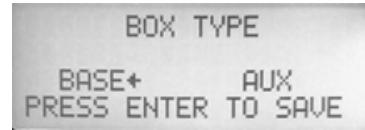

3)

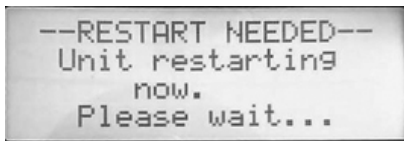

4)

Box Name

1. From the Setup Menu screen, select General.
2. Select a Box Name from the list.
3. Press Enter to save.

Note: If "Other" is selected, use the Keypad and Arrow buttons to enter each letter or number. (The maximum number of characters is eight.) **It is important to note that the landline modem will only voice the box names that are in the list.**

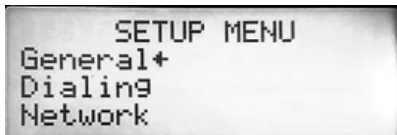

1)



2)

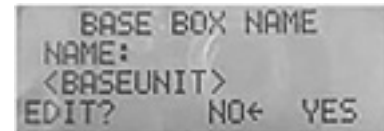

3)

Alert Delay

The Alert Delay setting allows the user to delay an alert from being sent for X amount of time. This delay gives the condition time to clear (2 minutes and 50 seconds is the maximum delay).

1. From the Setup Menu screen, select General.
2. Select Alert Delay.
3. Press Enter to Save.

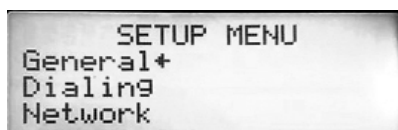

1)



2)



3)

Alert Suspend Time

The time after an alert has been Acknowledged to go back to inactive or call/text if still active. The maximum suspend time is 29:50 (min:seconds).

1. From the Setup Menu screen, select General.
2. Select Alert Suspend Time.
3. Enter the Alert Suspend time.
4. Press Enter to Save.

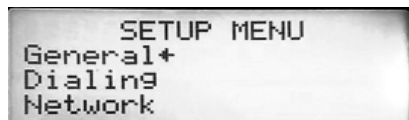

1)

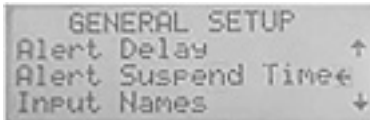

2)



3)

Alert Digital Inputs Naming

You can name up to eight different alert inputs. These inputs are normally open. See diagram wiring for proper wiring to the inputs. A specific name can be assigned to inputs by selecting (Other) from the Input Name List.

Note: **The landline modem will only voice the names in the list.**

1. From the Setup Menu screen, select General.
2. Select Input Names.
3. Select the Input you want to name/rename.
4. Select a Name for the Input from the list. Available Input names are Other, Gen Temp, Gen Batt, Low fuel, SP, Max Temp, Min Temp, Temp, Door 2, Door 1, Water press, Gen Sw, Gen, Input01, Input02, Input03, Input04, Input05, Input06, Input07, and Input08.
5. If "Other" is selected use the Keypad and Arrow Buttons to enter each letter or number. (The maximum of letters and numbers is eight.)
6. Press Enter to Save.

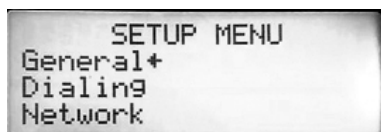

1)

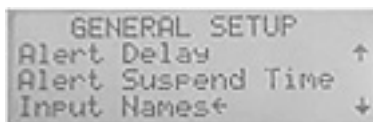

2)

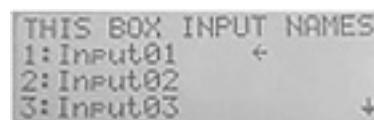

3)

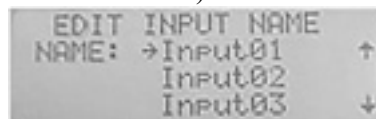

4)

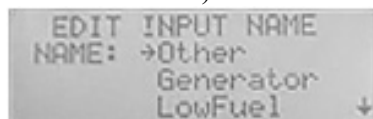

5)

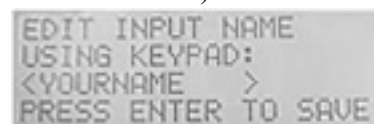

6)

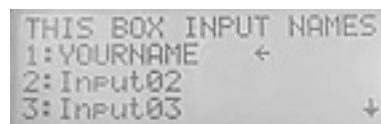

7)

Dialing

Enter the phone numbers you want to call or text in each of the modems and Server calls.

- Notes:
- Depending on your local system some Landlines will need a 1 added to the front of the phone number.
 - All Server numbers Voice and Text need a 1 added in front of the phone number.

Landline Dialing

If a landline is not used, go to the cellular dialing section.

1. From the Main Menu, select Setup.
 2. Select Dialing.
 3. Select Landline Calling and press Enter.
 4. Select Dialing Numbers.
 5. Select the line you want to change and press Enter.
 6. Enter the full phone number (including "1" if needed). Press Enter to save.
- Up to ten phone numbers can be assigned.

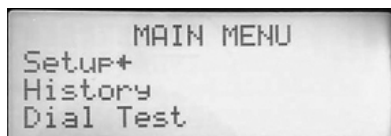

1)

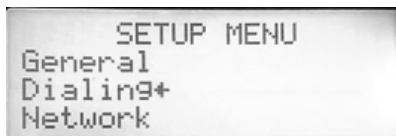

2)

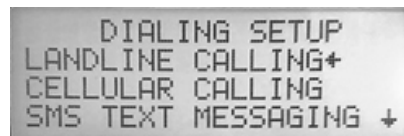

3)

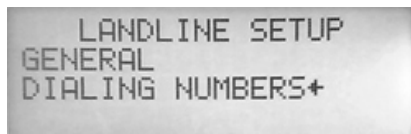

4)

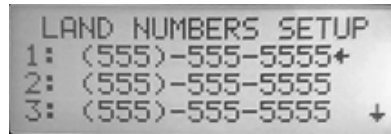

5)

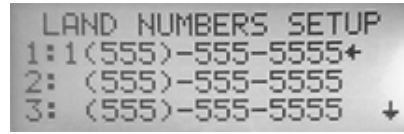

6)

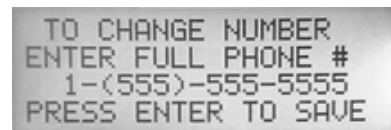

Cellular Dialing

1. From the Setup Menu select the Dialing Setup.
2. Select Cellular Dialing.

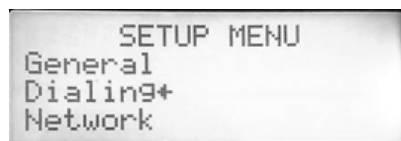

1)

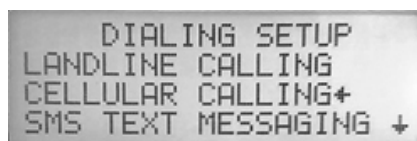

2)

Changing the Cellular Call Volume

Perform a test cell call in the Dial Test Menu before changing the default.

1. Select General
2. Select Call Volume
3. Change to desired call volume.
4. Press Enter to save.

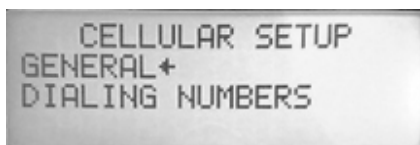

1)

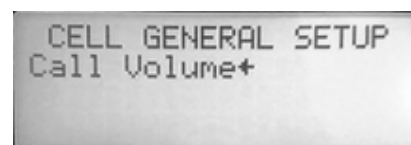

2)

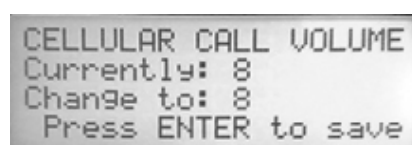

3)

Adding/Changing Cell Numbers

Perform a test cell call in the Dial Test Menu before changing the default.

1. Go to Dialing Setup Screen and select Cellular Calling.
2. Select Dialing Numbers
3. Select the line you want to change and select Enter.
4. Enter the full phone number. Once the number has been entered it will be saved. Up to 10 phone numbers can be assigned.



1)

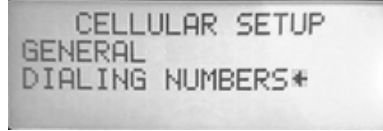

2)

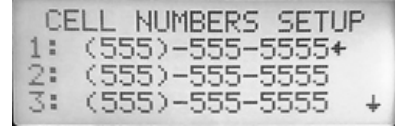

3)



4)

SMS Text Messaging

Warning! DO NOT text while operating any motored vehicle!

1. Go to the Setup Menu and select Dialing.
2. Select SMS Text Messaging.
3. Select General.
4. Select Acknowledge Delay. (Acknowledge delay is used to give the SMS message receiver time to acknowledge the text message. It can be set from 10 seconds to 5:50 minutes/seconds.
5. Press Enter to save.

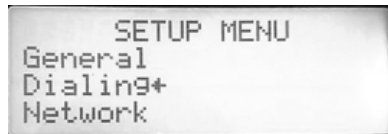

1)



2)

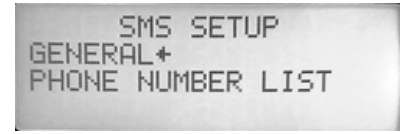

3)

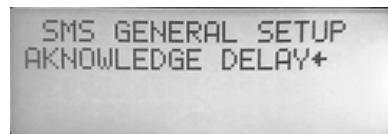

4)



5)

Adding/Changing SMS Text Numbers

1. Go to the Setup Menu and select Dialing.
2. Select SMS Text Messaging
3. Select Phone Number List.
4. Select the number you want to change and press Enter.
5. Enter the full phone number. as soon as the last number is entered, the SMS number will be saved. Enter is not needed. Up to 10 phone numbers can be assigned.

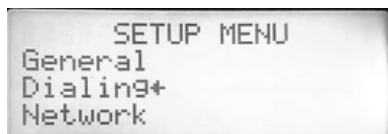

1)

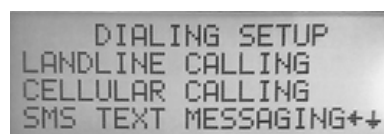

2)

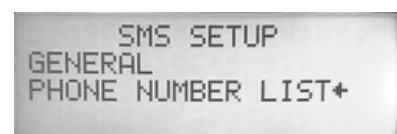

3)

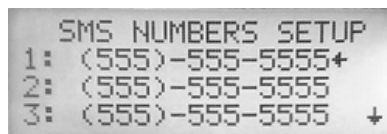

4)

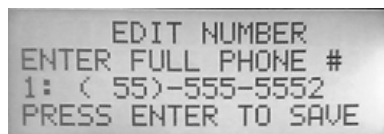

5)

Server Voice and Texting Dialing

Note: All Server numbers Voice and Text need a "1" added in front of the phone number.

1. From the Setup Menu, select Dialing.
2. Select Server Calling.
3. Select Dialing Numbers.
4. Select the number you want to edit.

Note: The Server Call Numbers list does not represent an order of dialing—It is just a list of numbers from which you can select.

5. Enter the full phone number, including a "1" at the front.
6. Press Enter to Save. The Server Call Numbers list displays with the updated number.

Note: Setting up Server Texting uses the same basic procedure. Select Server Texting from the Dialing Setup screen, then follow steps 3 through 6.

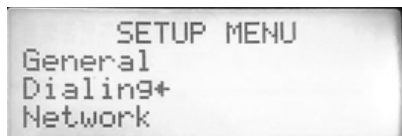

1)

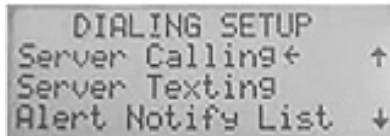

2)

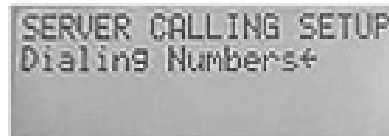

3)



4)

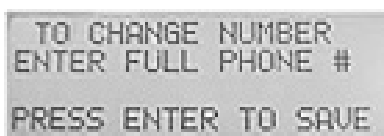

5)



6)

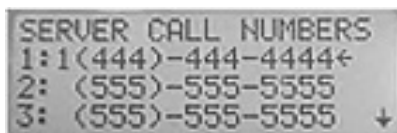

7)

Alert Notify List

The Alert Notify List is a list of up to 10 numbers selected from any of the numbers entered in the DIALING SETUP menu. The numbers can be selected from any of the five different dialing lists: Landline, Cellular, SMS, Server Voice, and Server Text. The Alert Notify List can be any order you need.

1. From the Setup Menu, select Dialing.
2. From the Dialing Setup screen, scroll down to Alert Notify List and press Enter.
3. Select a number (1 in the example below) in the list and press Enter.
4. Select Edit to change the number or select Delete to delete the number.
5. If editing, use the Arrow Buttons to edit the letter and number. The numbers can be selected from any of the five different dialing lists (Landline, Cellular, SMS, Server Voice, and Server Text).
6. Press Enter to save edits.

Number prefixes are as follows:

- C= Cellular
- T= SMS Text
- P= Landline
- SV = Server Voice
- ST = Server Text

Examples: (C5) Cellular list, fifth number in the list.

(T4) SMS list, fourth number in the list.

(P1) Landline list, first number in the list.

(SV3) Server Voice list, the third number in the list..

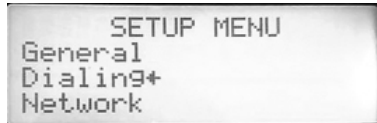

1)

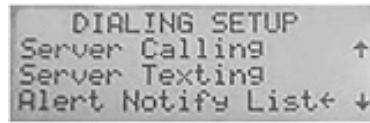

2)

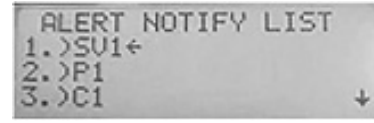

3)



4)



5)

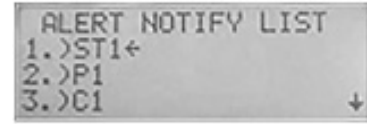

6)

Acknowledgment Code

This code is used to Acknowledge all types of Alert calls.

Note: **The default Acknowledgment code is 123456. We recommend that a new code be assigned.**

1. From the Setup Menu, select Dialing.
2. From the Dialing Setup screen, scroll down to Acknowledgment Code and press Enter.
3. The current code is displayed. Press Enter to edit.
4. Use the Number Pad and Arrow Buttons to edit.
5. Press Enter to save.

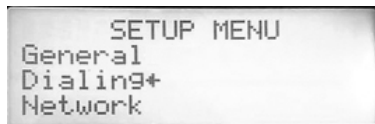

1)

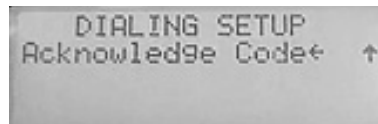

2)

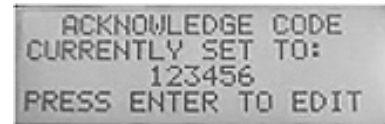

3)

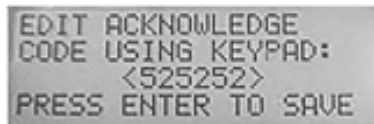

4)

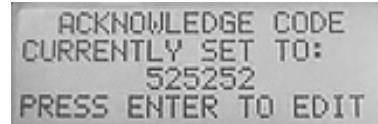

5)

Network Setup

Connect all devices to the local Ethernet network (CT3, Broadcaster, and or Broadcaster Aux Box).

The Base Box communicates via Ethernet IP addresses.

In most of the installs, a Dynamic IP is used in the Broadcaster.

The IP is determined by the connected Router.

All connected devices must be in the same range as the Broadcaster's IP range.

A Static IP is used in the CT3 and Broadcaster Aux Box.

A Static IP will be used on the Base Box if only a Landline and or Cell calling is used. (No Server)

LAN Network

Determine the LAN IP range.

If a router has been installed, see what its LAN IP is and use that IP range to set all the other devices connected to the network. If the router has not been installed, a good IP range to use would be 192.168.2.xxx. The first three numbers must be the same and the last numbers must be different to all the connected devices.

Base Box Network Setup

Setup Static or Dynamic IP Address

The factory default is set to Dynamic. Follow the steps below to change to a Static IP.

1. From the Setup Menu and select Network.
2. Select Configure Network and press Enter.
3. Select Static IP.
4. Select YES and press Enter to confirm your choice.
5. Select YES to edit the Static IP Address and press Enter.
6. Use the Number Pad and Arrow Buttons to edit the current IP address and press Enter to save.
7. Press the Back button to confirm. The Broadcaster will restart.

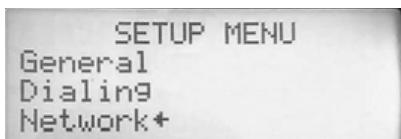

1)



2)

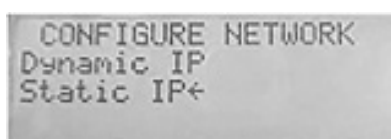

3)



4)

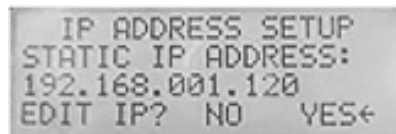

5)

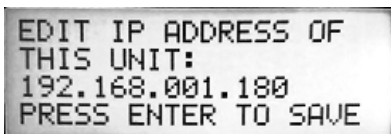

6)

Subnet Mask

The Subnet Mask is assigned by the Router.

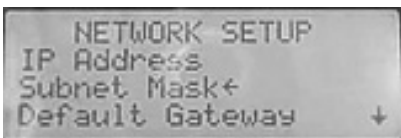

1)

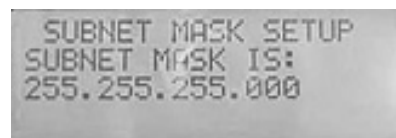

2)

Default Gateway

The Gateway is assigned by the Router.



1)



2)

Approved AUX List

Approved AUX List is a list of all devices (Chore-Tronics® 3 and Auxiliary boxes) that are to be monitored by the Base Box.

Adding Chore-Tronics® 3 Controls and Auxiliary Boxes

1. Select Approved Aux List in the Network Setup Screen.
2. To add a Chore-Tronics® 3 or Auxiliary box, press Enter on line 1.
3. Select Edit and press Enter.
4. Select CT3 or AUX and press Enter. Both are added in the same way. This example displays adding a CT3 control.
5. Scroll down the list of approved Names and select a Name by pressing Enter. The choices are Office01, Office02, and House01 through House20.
6. Enter the IP address of the connecting unit.
7. Select Click Here to Add and press Enter.
8. Follow the same steps to add the remainder of the units that are connected.
9. After all the units have been added, press the Back Button.
10. Select Yes to save and restart the unit.



1)

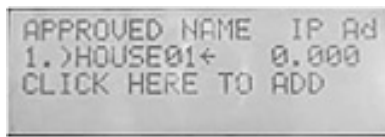

2)



3)



4)



5)



6)



7)



8)

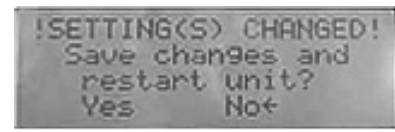

9)

Sleep Mode

The Sleep Mode feature allows the user to disable alerts from a specific house, houses, and/or Aux box.

The Base Broadcaster box will not send any Alerts from the selected units that are in the Sleep Mode.

The time can be set from 1 hour to a maximum of 30 days.

Setup Sleep Mode

1. From the Current Condition screen, press the Back button to go to the Main Menu.
2. Select Setup.
3. Select Network.
4. Select House Sleep Mode.

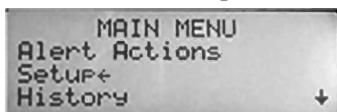

1)

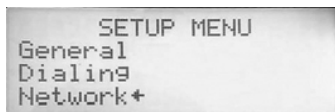

2)



3)

5. Select Click Here to Add.

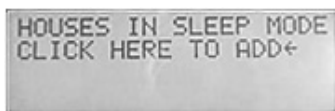

4)

6. Select a House Name using the Up and Down Arrows and press Enter to save.

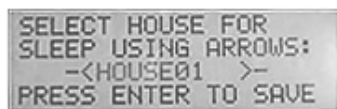

5)

7. Use the arrows to edit the number of days and hours and press Enter to save.
The example below displays 30 days, 0 hours in Sleep Mode. Thirty days is the maximum Sleep time.



6)



7)

Note: The number of houses in the Current Condition screen will change by the number of houses in Sleep Mode. The number of houses in Sleep mode are displayed in the Current Condition screen.

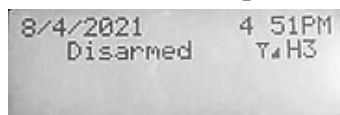

8)

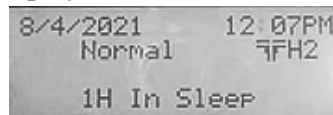

9)

Editing, Viewing, or Deleting Sleep Mode

1. From the Network Setup menu (Main Menu→Setup→Network), select House Sleep Mode.
2. Select the House Name.

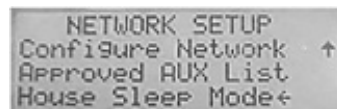

1)

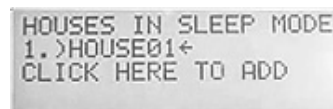

2)



3)

3. Select either Edit or Delete. If you select Delete, the selected House is removed from the Sleep Mode list. It will no longer be in Sleep Mode and will be on line.
4. If you select Edit, use the arrows to edit the end date and time.
5. Press Enter to save.



4)



5)

Placing the Base Box in Sleep Mode

Note: **No Alerts will be sent from any connected device (CT3, Aux Box, or Input) when the Base Box is in Sleep Mode.**

1. From the Network Setup menu (Main Menu->Setup->Network), select House Sleep Mode.
2. Select the Click Here to Add.
3. Select the Base Unit.
4. Use the arrows to edit the end date and time.
5. Press Enter to save.



1)

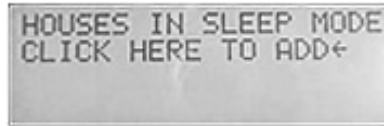

2)

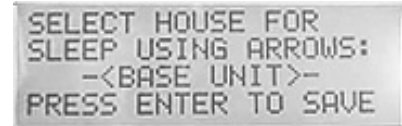

3)



4)

Note: **The Current Condition screen will display the Broadcaster is in Sleep Mode.**

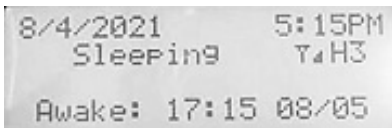

5)

History

View History

1. Select History from the Main Menu.
2. Select View History.
3. The latest Alerts will be displayed.
4. Arrow down to see more past alerts.

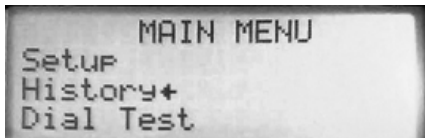

1)

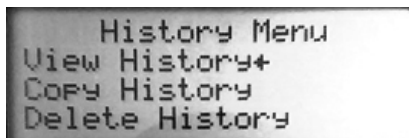

2)

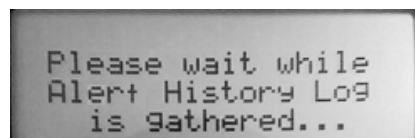

3)

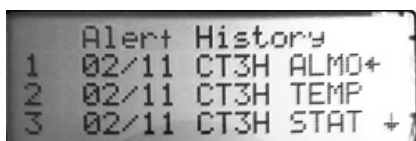

4)

Copy History

A USB drive is needed to download history.

DANGER: Electrical Hazard

1. Remove all power sources from the Broadcaster™.
2. Insert the USB drive in the USB Hub.



USB Drive

USB Hub



3. Power the Broadcaster™ back up.
4. Select History from the Main Menu.
5. Select Copy History.
6. Select Yes and Press Enter. The History is now copied to the drive.

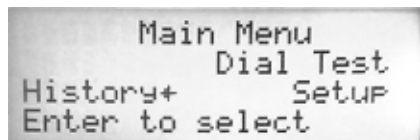

4)

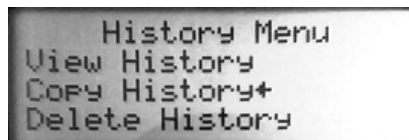

5)

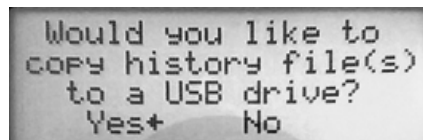

6)

7. Remove all power sources from the Broadcaster™.
8. Remove the USB drive. Close the front panel and tighten all the screws.
9. Plug in the power adapter and place the battery backup switch to On. This will update the Broadcaster™ Software.

Auxiliary Box Setup

Box Type (Auxiliary)

1. From the Main Menu, select Setup.
2. Select General.
3. Select Box Type.
4. Select AUX and press Enter.
The Broadcaster™ will restart.

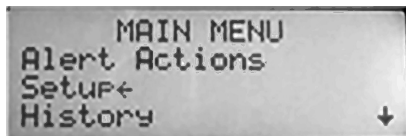

1)

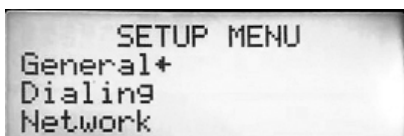

2)

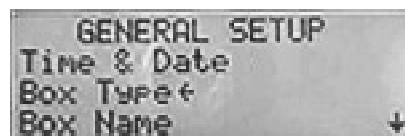

3)

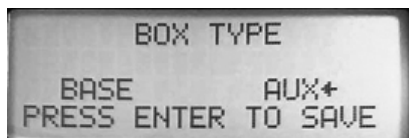

4)

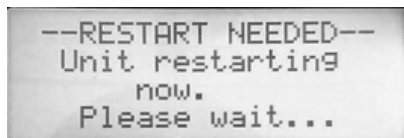

5)

Time and Date (Auxiliary)

1. From the Main Menu, select Setup.
2. Select General.
3. Select Time and Date.
4. Select Set Time and Date.
5. Edit the Time and Date with the Arrow Buttons.
6. Press Enter to save.

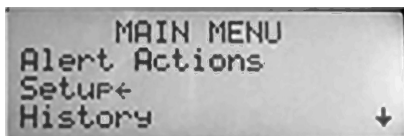

1)

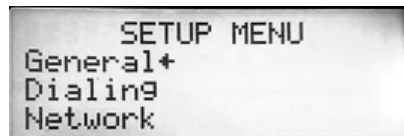

2)

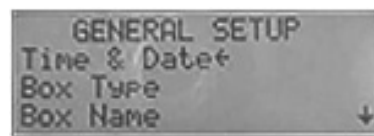

3)

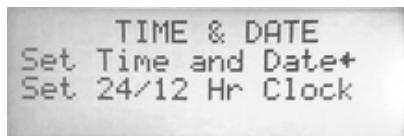

4)

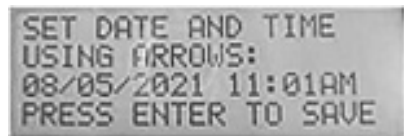

5)

Auxiliary Box Clock Format

1. From the Time & Date screen, select Set 24/12 Hr Clock.
2. Move the Pointer to Yes.
3. Press Enter to change from the current format.

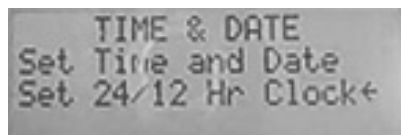

1)

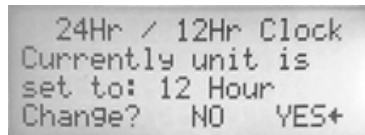

2)

Auxiliary Box Names

1. Go to the Main Menu and select Setup.
2. Select General.
3. Select Box Name and press Enter.
4. Select Yes and press Enter.
5. Select a Name from the Aux Box Name list and press Enter.

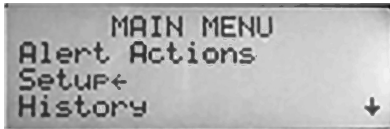

1)

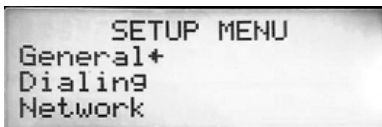

2)

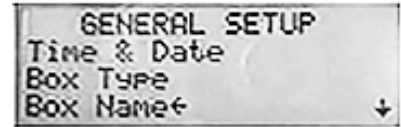

3)

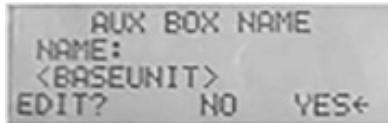

4)



5)

Alert Names (Aux.)

Refer to the Base Box Alert Digital Inputs Naming procedure. See page 13.

Alert Box Network Setup

Refer to the Network Setup procedure. See page 18.

Note: **The Auxiliary Box will always be set to a Static IP.**

Broadcaster™ Testing

Warning: This Device must be tested at least once a week. Failure to do so can result in no alert notification and a loss of production.

Call/Text Testing

SMS Text Message—A Weekly text message will be sent every Wednesday at noon (the date and time must be set up correctly). The message only goes to the first text number in the list and will be sent only one time. Sending the correct acknowledgment code will conclude the test and it will be recorded that the user responded to the test.

Server Calling and Texting—It is recommended that a test call be run one time per week. This can be done from the Dial Test Screen.

Note: A "1" must be entered in front of all Voice and Text call numbers.

Example: Sever Voice test call. Result: You should receive a call with the status.

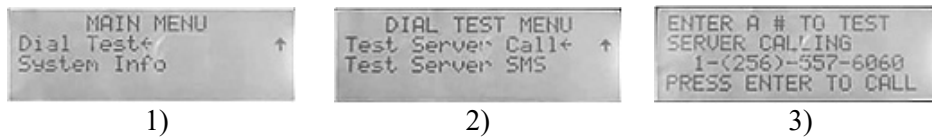

Example: Sever Test Text. Result: You should receive a call with the status.

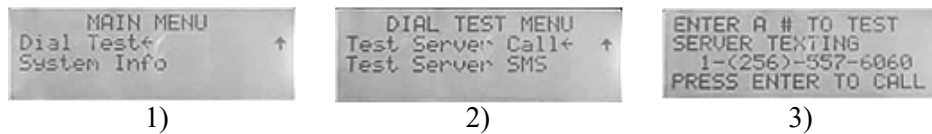

Cellular Calling—It is recommended that a test call be run one time per week. This can be done from the Dial Test Screen.

Landline Calling—It is recommended that a test call be run one time per week. This can be done from the Dial Test Screen.

System Alert Testing

It is recommended that at least 1 time per week, a test alert is sent from the control(s) being monitored. It is recommended that the alert be allowed to move through every number in the notify list to make sure that number is called and/or sent an SMS message.

Battery Testing

It is recommended that at least 1 time per month, the battery is checked on the Broadcaster™. To check the battery, remove the power cord and allow the system to keep running on the battery backup. Allow the Broadcaster™ to contact all numbers on the notify list before ending the test. The battery should have enough power to go through the entire notify list at least one time. If it cannot, then the battery must be changed.

Testing Modems

Landline Modem Testing

Note: Modems should be tested at least once per week.

1. Select Dial Test from the Main Menu.
2. Select TEST LANDLINE.
3. Enter the Phone number you want to call.
4. As soon as the last number is entered the Broadcaster™ will start dialing. Answer the call and enter your Acknowledge code.

```

Main Menu
  Dial Test+
History   Setup
Enter to select
  
```

1)

```

Dial Test Menu
TEST LANDLINE+
TEST CELLULAR
TEST SMS
  
```

2)

```

ENTER A # TO TEST
THE LANDLINE MODEM
<(555)-555-555 >
  
```

3)

```

Dialing...
  
```

4)

Cellular Modem Testing

Note: Modems should be tested at least once per week.

1. Select Dial Test from the Main Menu.
2. Select TEST CELLULAR.
3. Enter the phone number you want to call.
4. As soon as the last number is entered the Broadcaster™ will start sending a text.
5. When you receive the text, enter the correct acknowledgment code.

```

Main Menu
  Dial Test+
History   Setup
Enter to select
  
```

1)

```

Dial Test Menu
TEST LANDLINE
TEST CELLULAR+
TEST SMS
  
```

2)

```

ENTER A # TO TEST
THE CELLULAR MODEM
<(256)-557-606 >
  
```

3)

```

Dialing...
  
```

4)

SMS Texting Modem Testing

Note: Modems should be tested at least once per week.

1. Select Dial Test from the Main Menu.
2. Select TEST SMS.
3. Enter the phone number you want to call.
4. As soon as the last number is entered the Broadcaster™ will start sending a text.
5. When you receive the text, enter the correct acknowledgment code.

```

Main Menu
  Dial Test+
History   Setup
Enter to select
  
```

1)

```

Dial Test Menu
TEST LANDLINE
TEST CELLULAR
TEST SMS+
  
```

2)

```

ENTER A # TO SEND
A TEST MESSAGE OUT
<< >- - >
  
```

3)

```

A SMS was sent.

Now waiting for
a response SMS
  
```

4)

```

.. hanging up...

Now waiting for
Na response SMS....#
  
```

5)

Updating Broadcaster™ Software

DANGER: Electrical Hazard

1. Remove all power sources from the Broadcaster™.
2. Insert the USB drive in the USB hub. Power the Broadcaster™ back up.

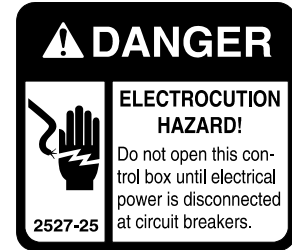
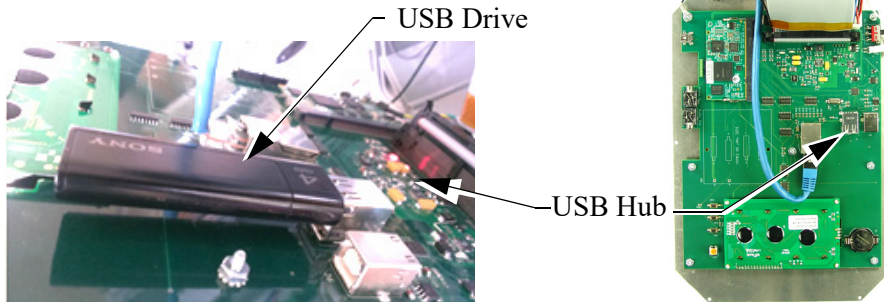

3. Go to the Main Menu and select System Info.
4. Scroll down to Update OS (EXPERT) and press Enter.
5. Select Yes to start the update.

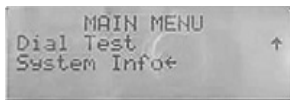

1)



2)

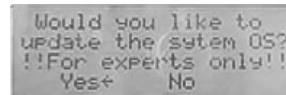

3)

6. The Broadcaster™ will restart when the update is done.
7. During the boot up process, one of the screens will display the new version level.
8. Remove all power sources from the Broadcaster™.
9. Remove the USB Drive. Close the front panel and tighten all the screws.
10. Plug in the power adapter and place the battery backup switch to ON.

Note: To check the current Broadcaster Version, go to the Main Menu and select System Info.

Hot Keys

Operator Panel Hot Key Combinations

Use the following number combinations to perform these operations from the Current Conditions Screen.

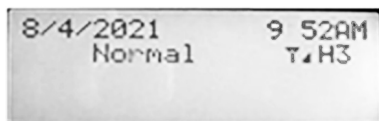

- 3 + 9 = Arm/Disarm
- 1 + 7 = Activate Cell Modem
- 2 + 5 = Acknowledge an alert

SMS Text commands

Send these text commands to the Base Unit via SMS message to perform the following.

- Space
- disarm 123456
- arm 123456
- reset 123456
- status 123456
- ack 123456, or 225123456

- Disarms the unit if already armed.
- Arms the unit if already disarmed.
- Performs a soft reset on the current system alert status
- Returns a SMS with the current system alert status
- Acknowledges any current alerts that are present.

Cell Modem Sim Card Installation (GSM/ATT)

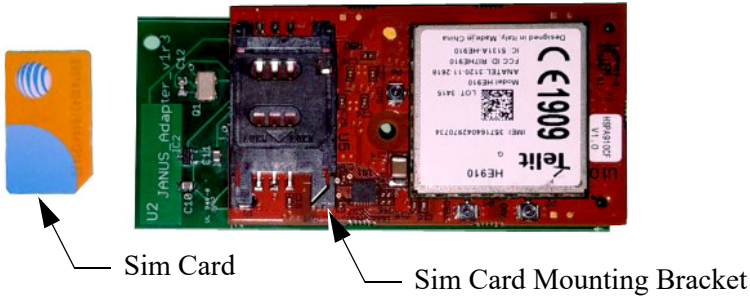

Step 1) Slide to Unlock

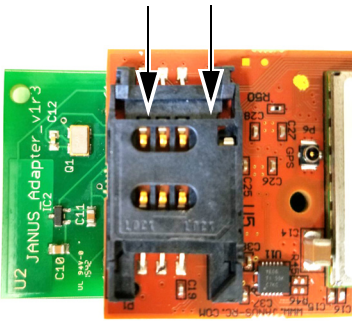

Step 2) Open Door

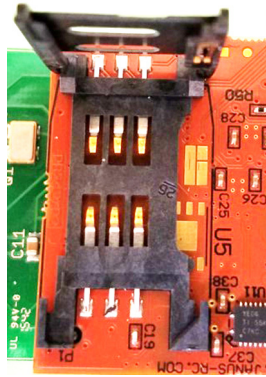

Step 3) Insert Sim Card

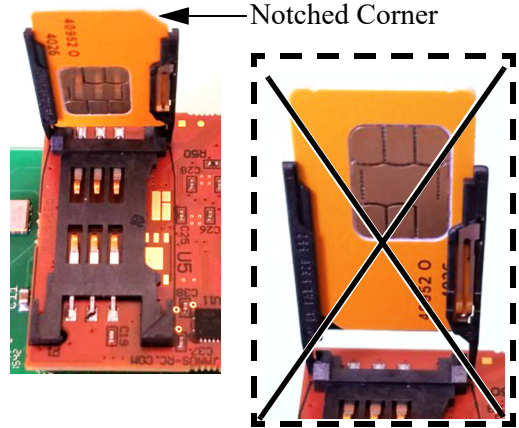

Step 4) Close the Door



Step 5) Slide to Lock

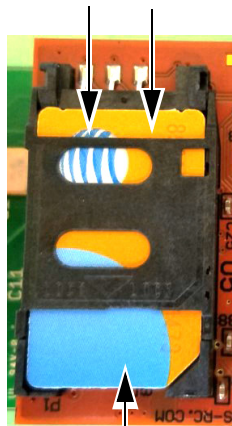

Push down slightly on Sim Card while sliding.

Wiring

Fiber Ethernet (Wiring)

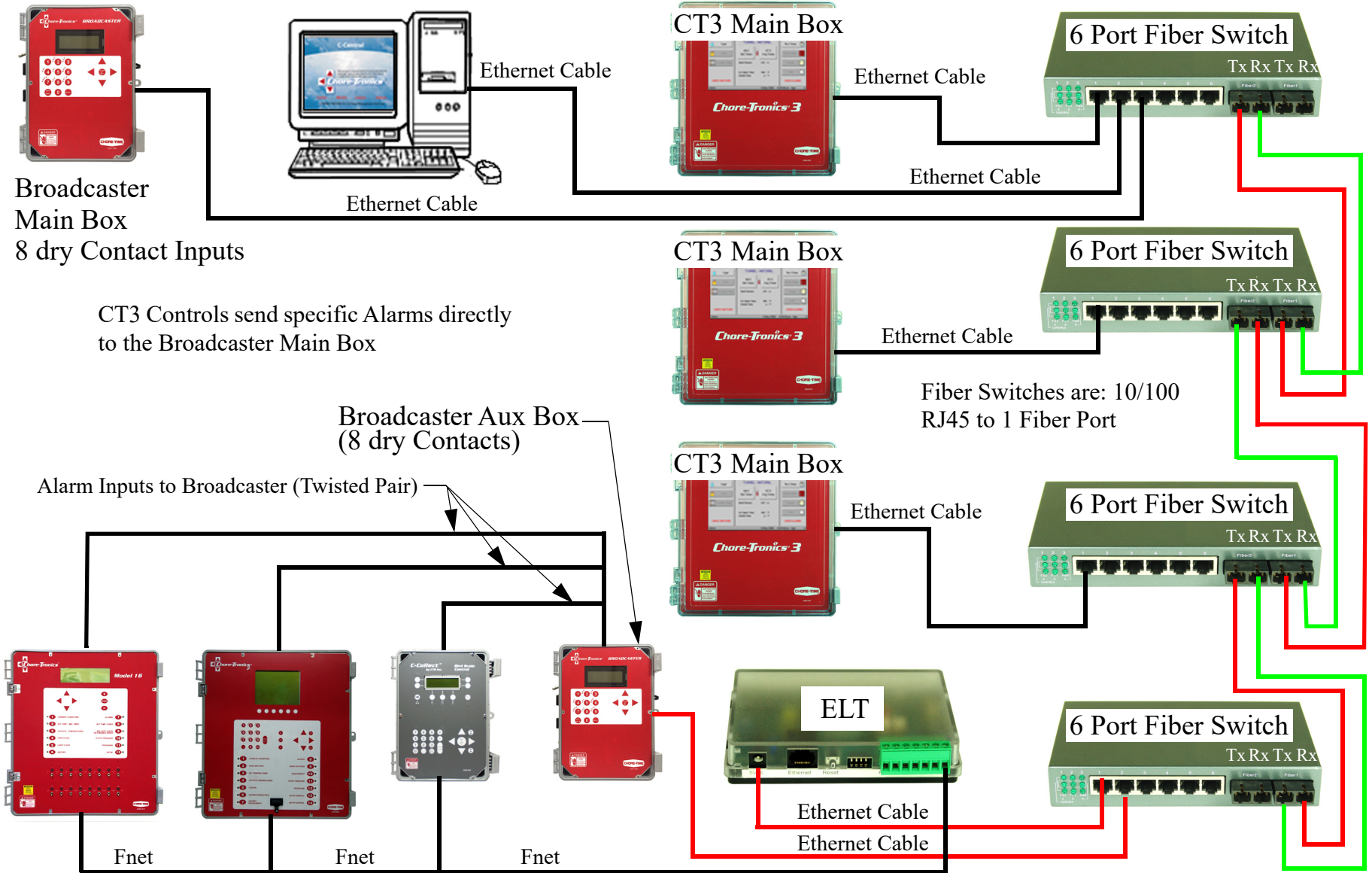

Wireless Radios (CT3 and other Chore-Tronics Controls) Wiring

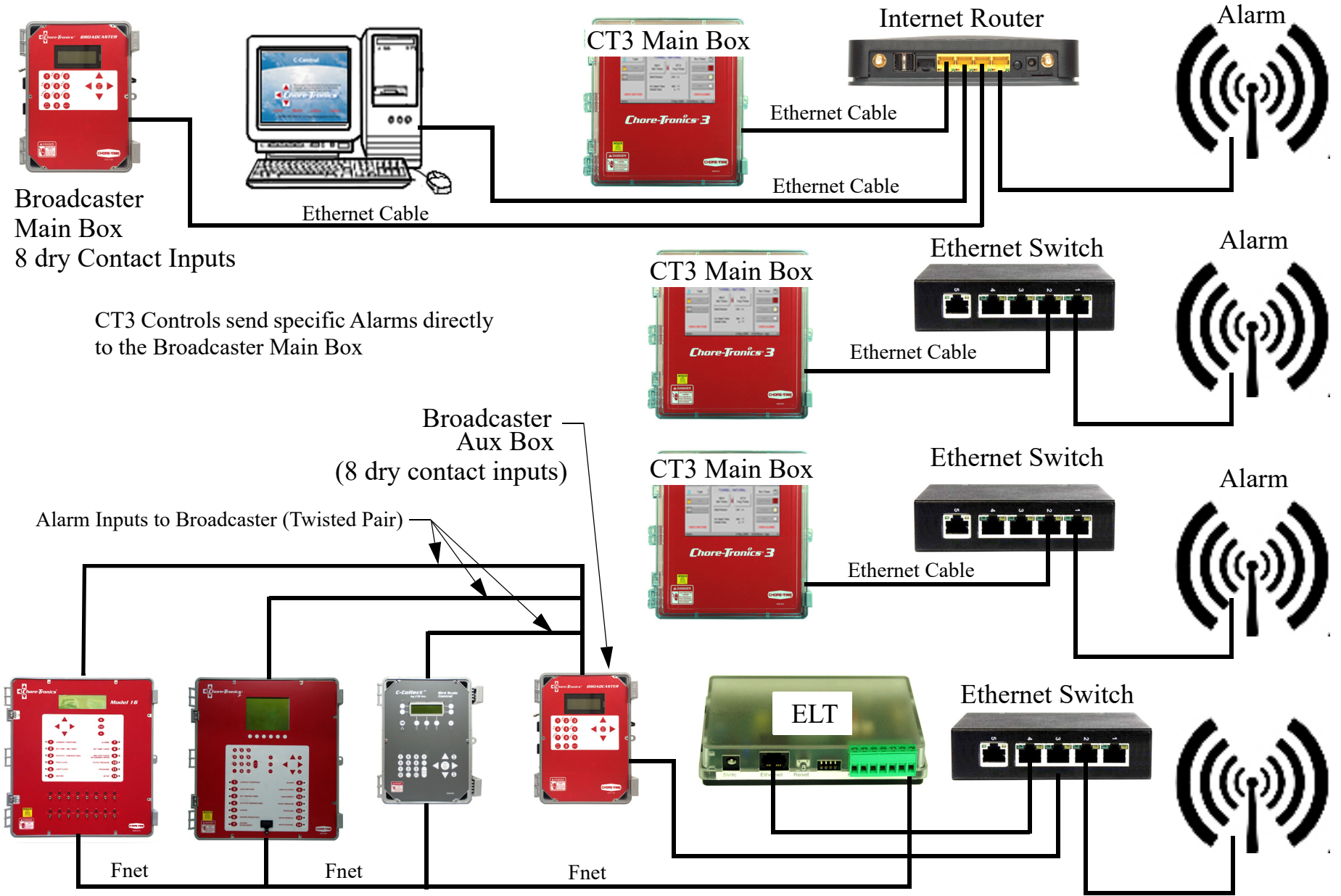

Ethernet Cat 5e-6 (CT3 and other Chore-Tronics Controls) Wiring

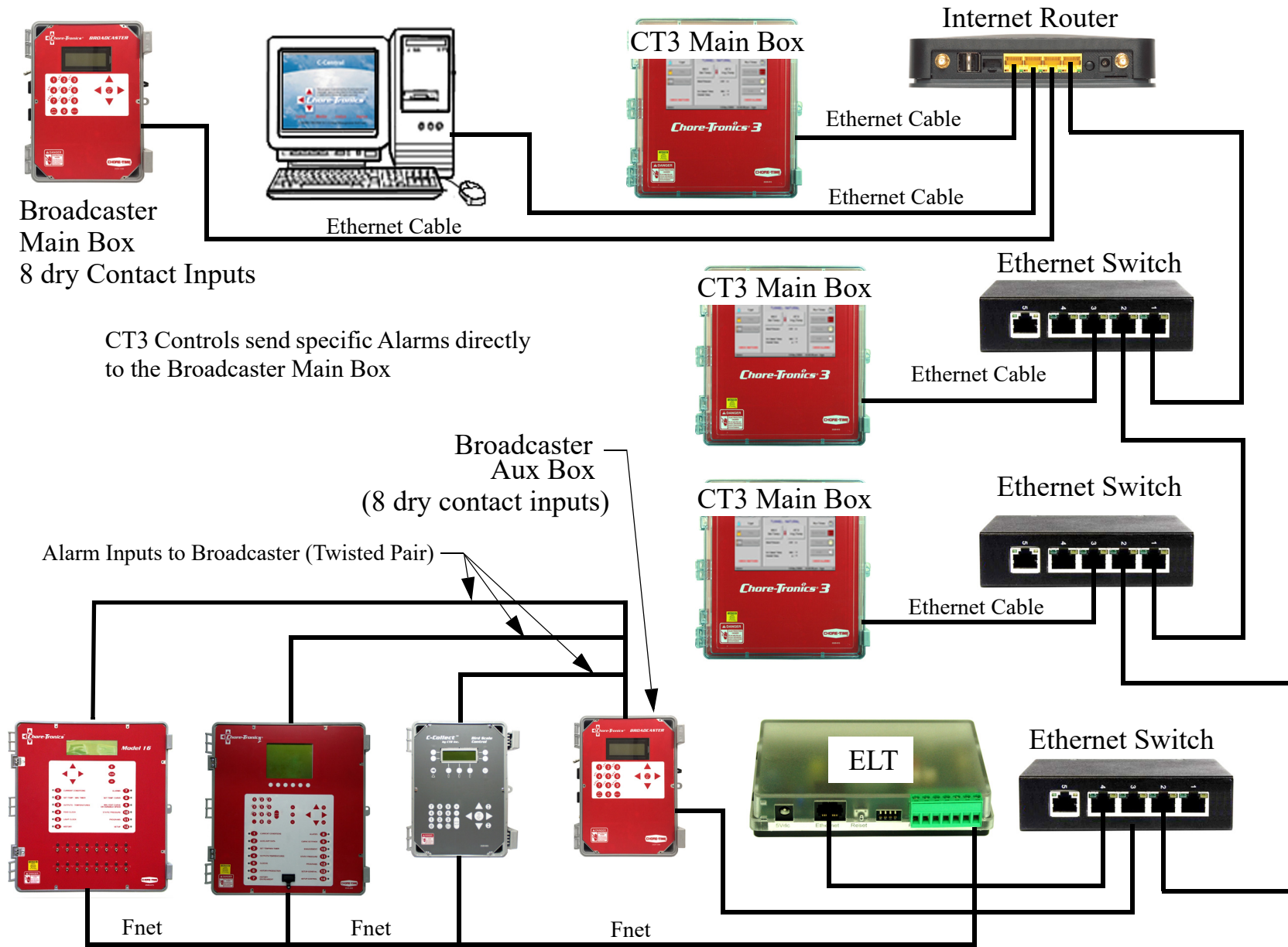

CT3 Controls send specific Alarms directly to the Broadcaster Main Box

Broadcaster Aux Box (8 dry contact inputs)

Alarm Inputs to Broadcaster (Twisted Pair)

Fnet

Fnet

Fnet

32 CT2 Alarm Relay Kit (50246) Wiring

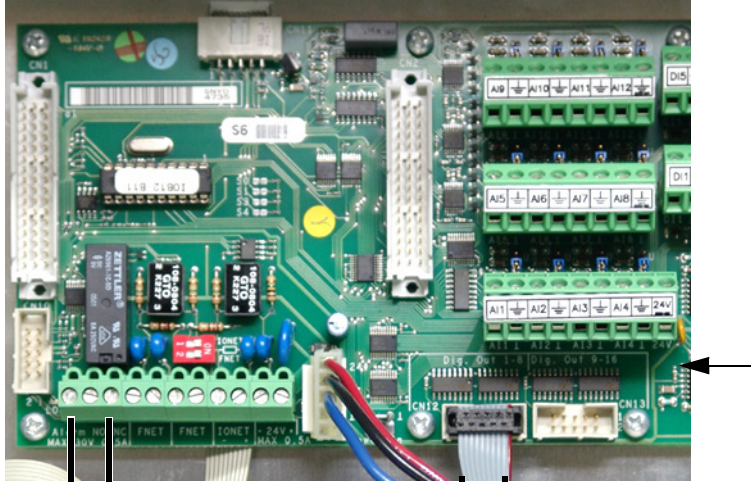

CT2 I/O Board

1. Connect the Flat Cable as shown.
2. Remove the Common Jumper Wired if not needed.
3. All outputs are SPDT dry contact (Com./NC./NC.)
4. Broadcaster connects to the Com and NO.
5. Outputs:
 1. High or Low Temperature on any mode temp sensor.
 2. High or Low Static Pressure.
 3. Low Water Pressure.

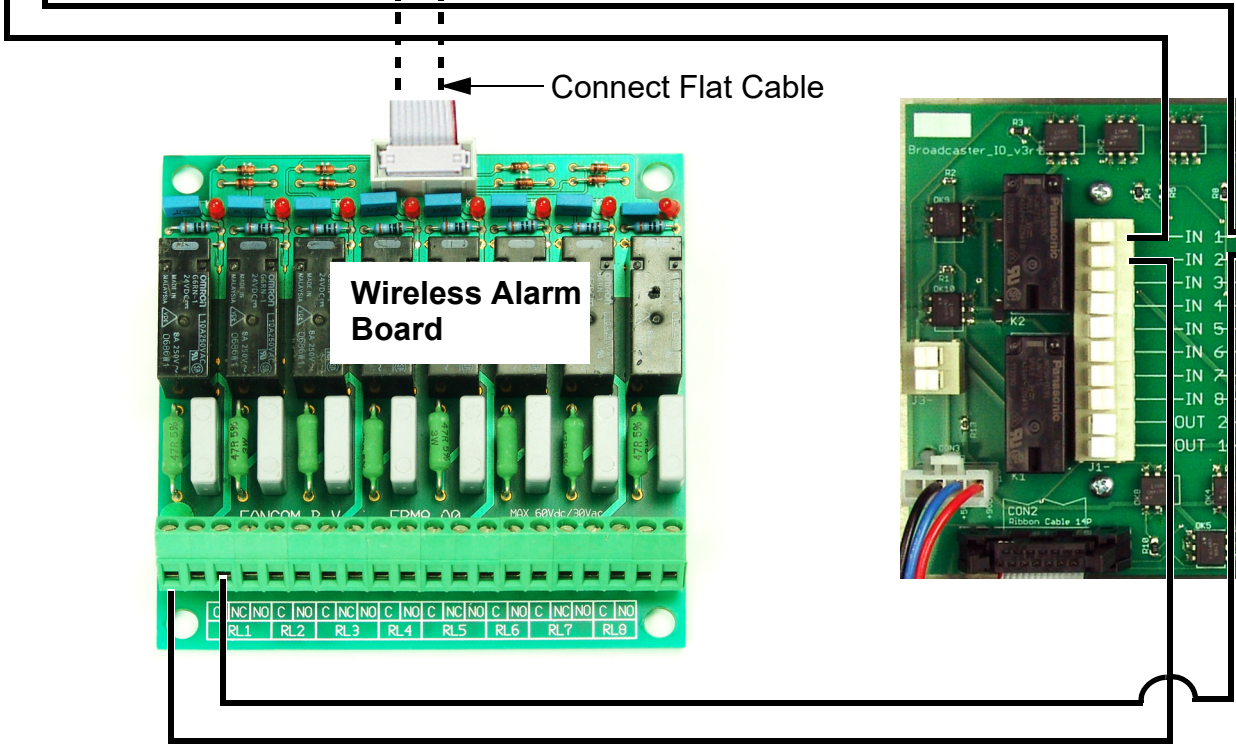

Connect Flat Cable

Wireless Alarm Board

Broadcaster I/O Board

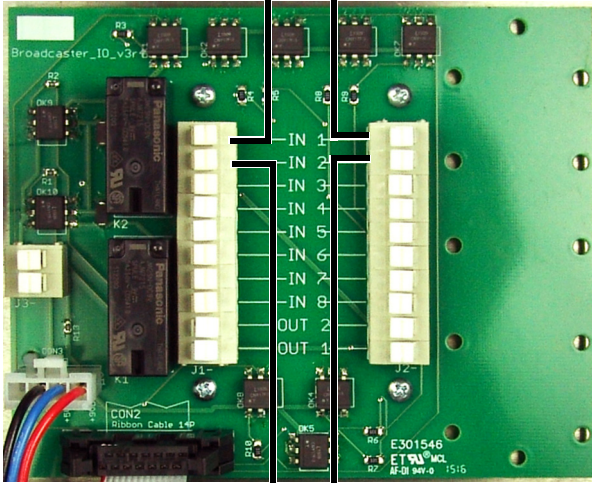
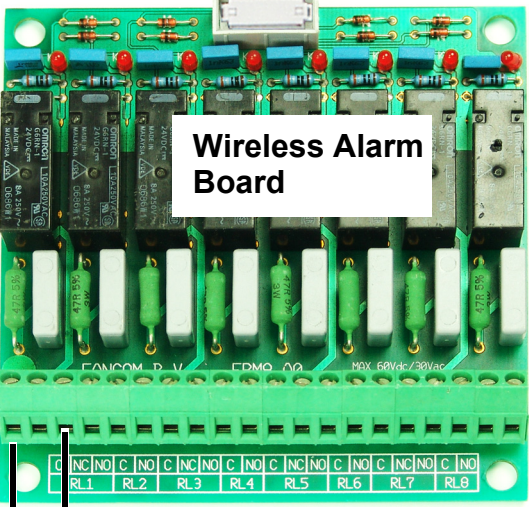

External Alert (Alarm) Wiring

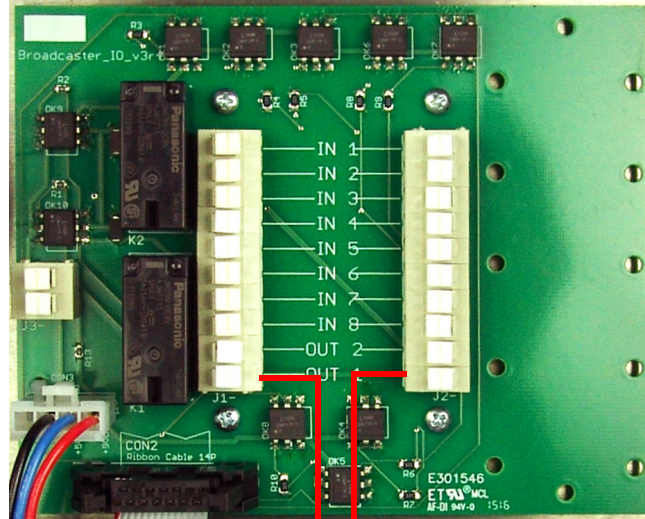

Broadcaster I/O Board

24 VDC or VAC Power Supply



24 VDC or VAC Coil

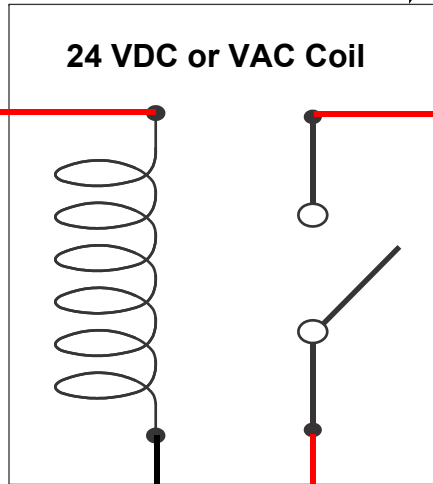

Max Load
3A @ 30VDC

External Alert Device

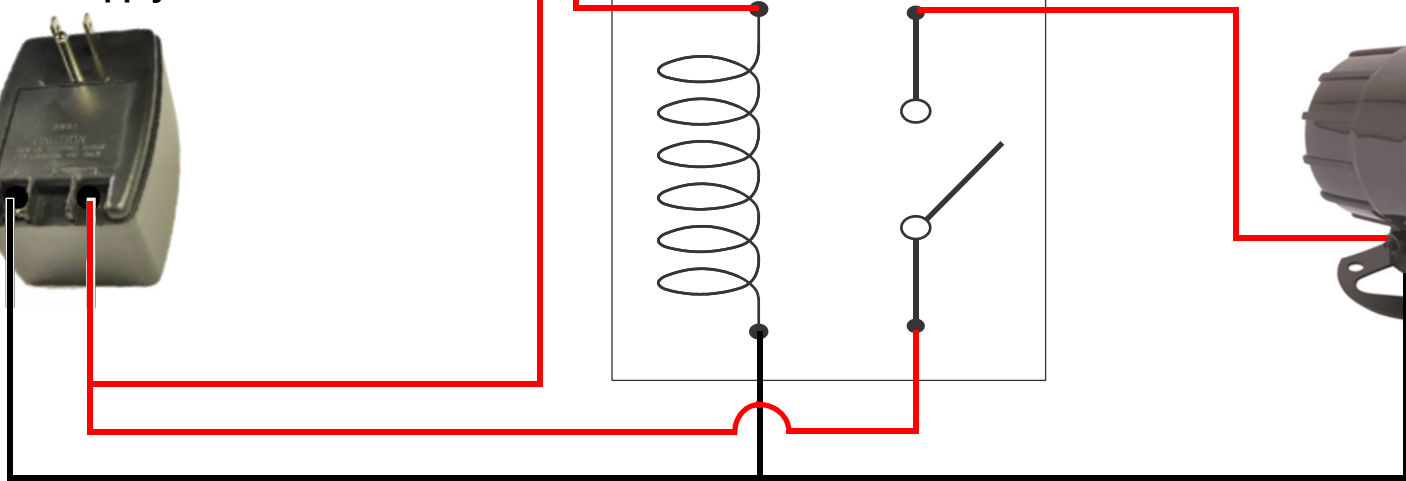

Generator Transfer Alert

Power Transfer Box Auxiliary Relay Connection Wiring

The Relay in the Transfer box that monitors the current mode of the Power Source must be connected to one of the eight inputs on the IO board.

A closed circuit is needed to get an alert.

This Input is still delayed by the Alert Delay Setting.

Test the wiring connections by performing a Generator Test Cycle. If no alert after the alert delay time, check all the connections and dialing setup.

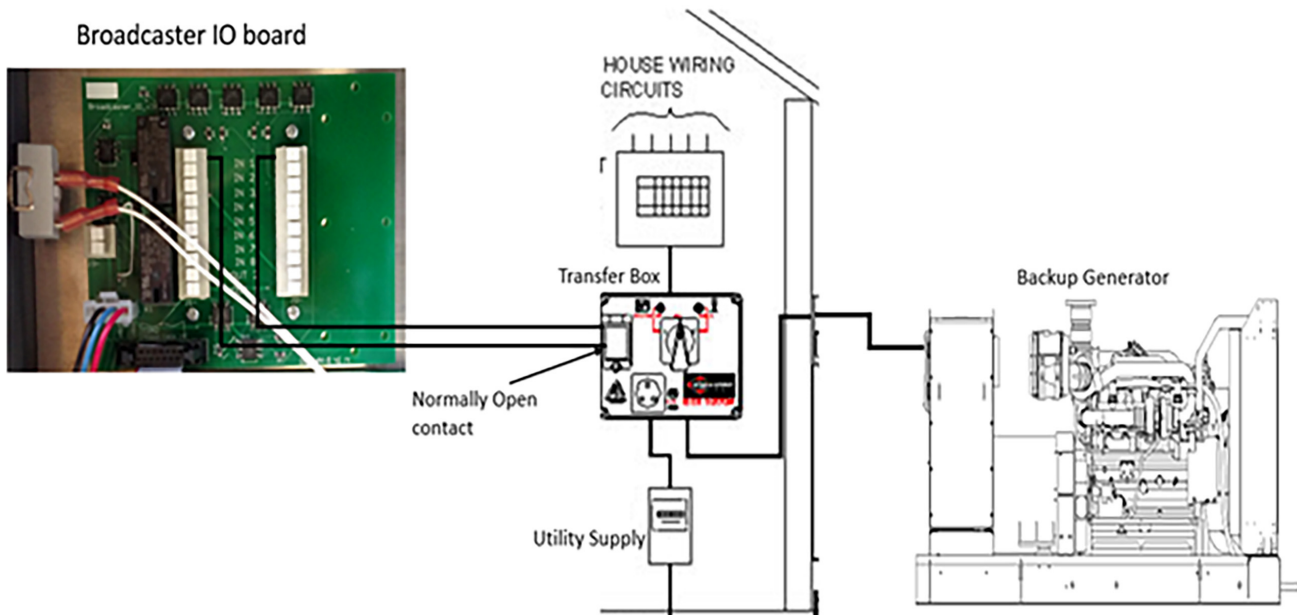

Broadcaster IO Board's Eight Digital Inputs

The eight inputs can be used to monitor any device that is connected to a relay that **Closes** for an alert. See the examples depicted below.

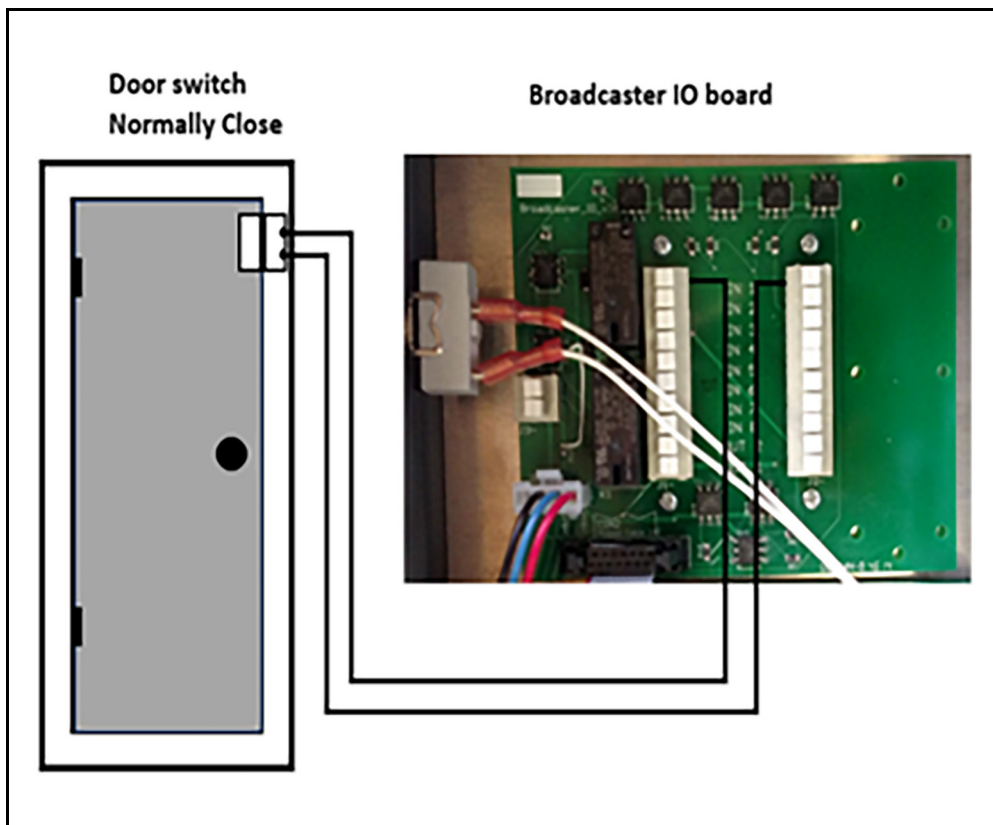
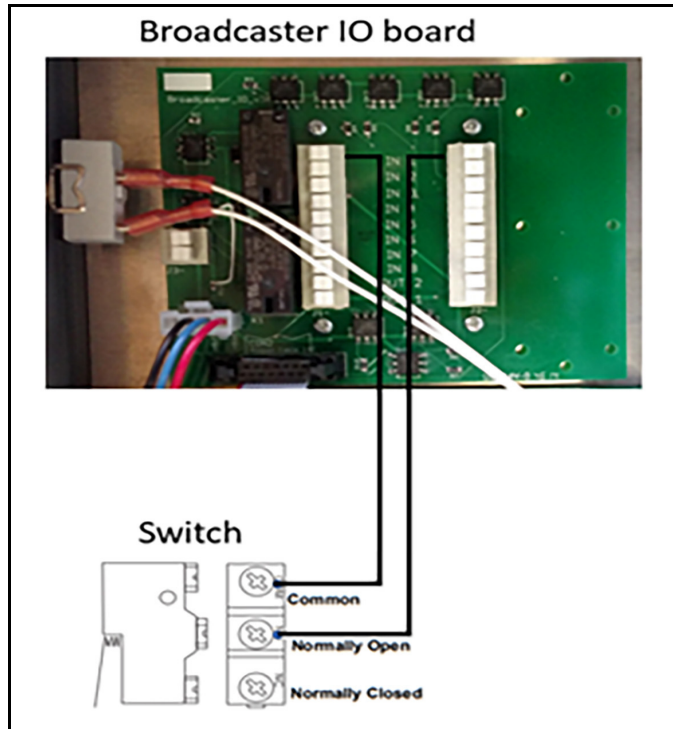

Parts Listing

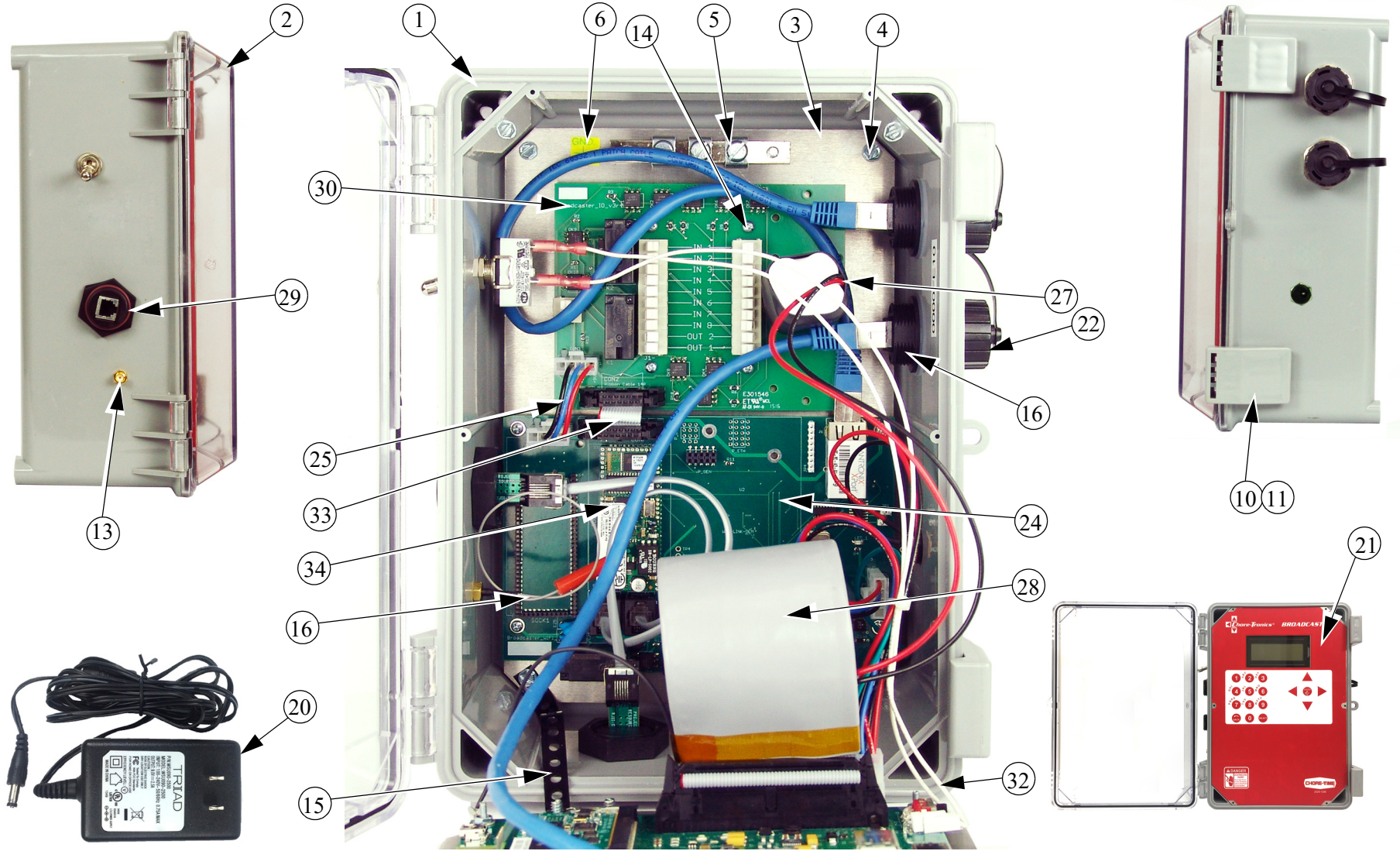

2434-020b 03/2014

Item	Description	Part No.
1	4 x 8 x 11 Control Box	30860-3
2	Plain Control Box Lid	30859-1
3	Ethernet alert Base Plate	54018
4	#8 x .375 HXWH Screw	13019
5	3.15 Grounding Rail	43384-2
6	Ground Symbol Decal	2527-63
7	Ethernet alert Top Plate	54017
8	Nylon Spacer	43383
9	4-40 CZ Hex Nut	3511
10	Control Box Latch	30862
11	Control Box Latch Pivot	30863
12	4-24 x .25 SS Panhd. Screw (Not Shown)	28696
13	SMA Dust Cap	55954
14	#4-40 X .25 Phil. Pan head Screw	46987
15	Strapping	29014-4
16	RP-SMA to U.FL 105 mm Cable	55967
17	Variscite SOM Module	56199
18	CAT5 Double Shielded Blue Cable	55951
19	Lithium Coin 3V 20mm Battery	55952
20	9V DC Power Supply	55568
21	Broadcaster Front Decal	2529-1096
22	Bulkhead Dust Cap	55954
23	Broadcaster Display	54015
24	Broadcaster WiFi	55569
25	IO Power Wire Harness	55955
26	Power Display Wire Harness	51962
27	AA Battery Wire Harness	55956
28	50 Pin Ribbon Wire Harness	55957
29	RJ-11 6p6c Bulkhead	55958
30	Broadcaster IO	54016
31	1/8 x 1 Rubber Cap (Not Shown)	55961
32	Switch Wire Harness	55959
33	14 Pin Ribbon Wire Harness	55960
34	Land Line Modem	55953

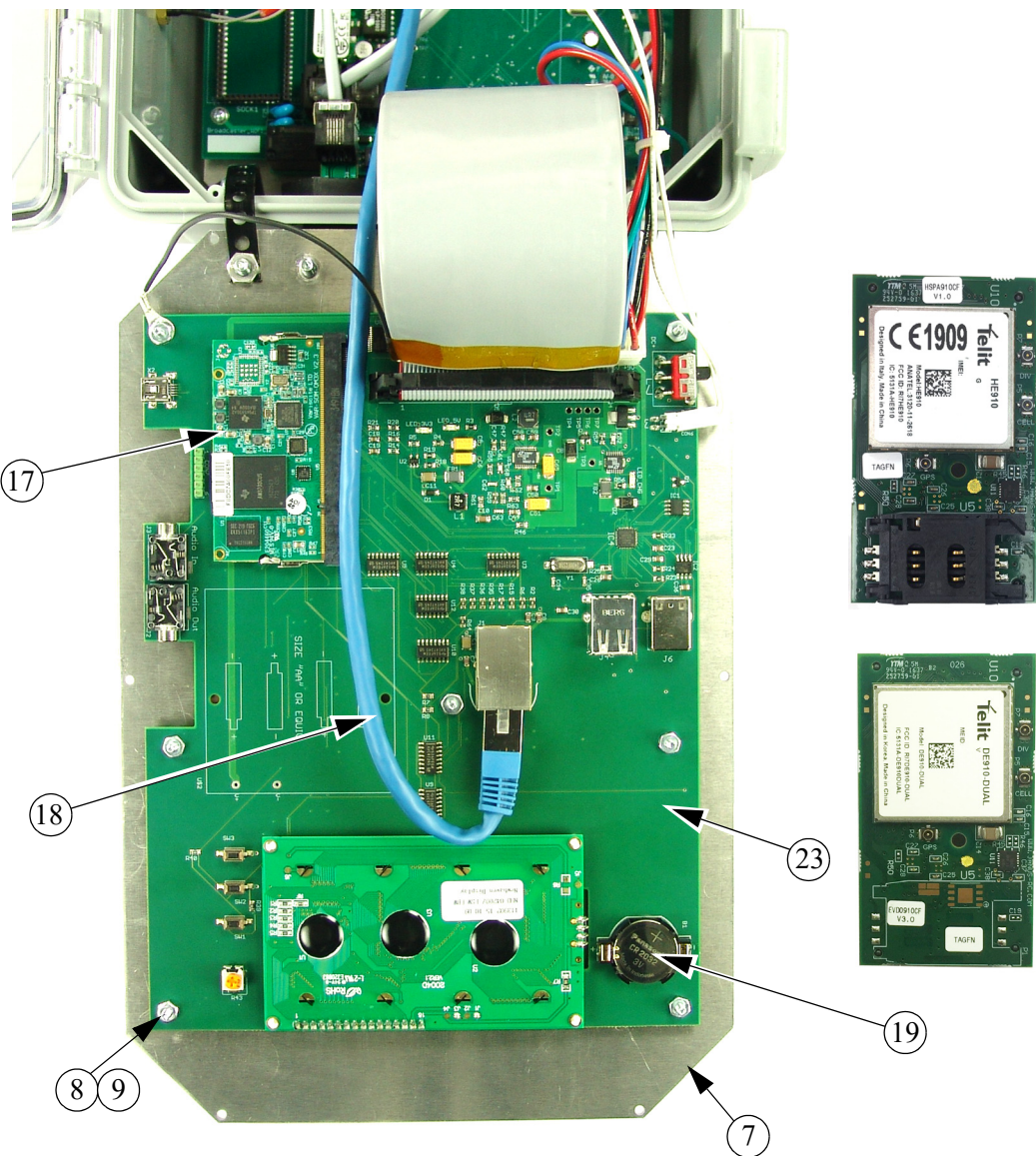

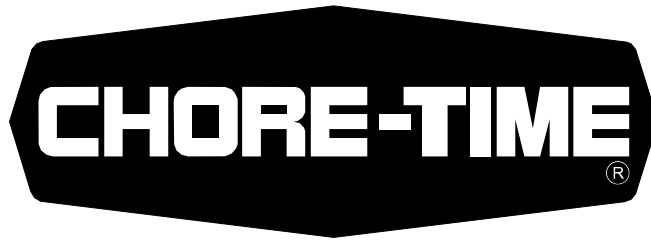

MADE TO WORK.

BUILT TO LAST.®

Revisions to this Manual

Page No.	Description of Change	ECO
Various	Numerous Updates	36032

Contact your nearby Chore-Time distributor or representative for additional parts and information.

CTB, Inc.
PO Box 2000
Milford, Indiana 46542-2000 USA
Phone (574) 658-4101
Email: choretime@choretime.com
Internet: www.choretime.com