

Owner/Operator Manual

FOR YOUR SAFETY

If you smell gas:

1. Open Windows
2. Don't touch electrical switches
3. Extinguish any open flame
4. Immediately call your gas supplier

POUR VOTRE SURETE

Si vous sentez une odeur de gaz:

1. Ouvrez les fenêtres
2. Ne touchez pas aux de commutateurs électriques
3. Éteindre n'importe quelle ouverture flambé
4. Immédiatement appeler votre fournisseur de gaz

Note: The original, authoritative version of this manual is the English version produced by CTB, Inc. or any of its subsidiaries or divisions, hereafter collectively referred to as "CTB"). Subsequent changes to any manual made by any third party have not been reviewed nor authenticated by CTB. Such changes may include, but are not limited to, translation into languages other than English, and additions to or deletions from the original content. CTB disclaims responsibility for any and all damages, injuries, warranty claims and/or any other claims of any nature associated with such changes, inasmuch as such changes result in content that is different from the authoritative CTB-published English version of the manual. For current product installation and operation information, please contact the customer service and/or technical service departments of the appropriate CTB subsidiary or division. Should you observe any questionable content in any manual, please notify CTB immediately in writing directed to: CTB Legal Department, P.O. Box 2000, Milford, IN 46542-2000 USA.

WARRANTY

CTB, Inc. warrants each new product manufactured by it to be free from defects in material or workmanship for one (1) year from and after the date of initial installation by or for the original purchaser. If such a defect is found by Manufacturer to exist within the one-year period, the Manufacturer will, at its option, (a) repair or replace such product free of charge, F.O.B. the factory of manufacture, or (b) refund to the original purchaser the original purchase price, in lieu of such repair or replacement. Labor costs associated with the replacement or repair of the product are not covered by the Manufacturer.

Conditions and Limitations

1. The product must be installed by and operated in accordance with the instructions published by the **Manufacturer or Warranty will be void.**
2. Warranty is void if **all components** of the system are not original equipment supplied by the **Manufacturer.**
3. This product must be purchased from and installed by an authorized distributor or installer or a certified representative thereof **or the Warranty will be void.**
4. Malfunctions or failure resulting from misuse, abuse, negligence, alteration, accident, or lack of proper maintenance, or from lightning strikes, electrical power surges or interruption of electricity, shall not be considered defects under the Warranty.
5. This Warranty applies only to systems for the care of poultry and livestock. Other applications in industry, commerce, or residential applications are not covered by this Warranty and are **strictly prohibited.** Any such use **will void the Warranty.**

Manufacturer shall not be liable for any **Consequential or Special Damage** which any purchaser may suffer or claim to suffer as a result of any defect in the product. *“Consequential” or “Special Damages” as used herein include, but are not limited to, lost or damaged products or goods, costs of transportation, lost sales, lost orders, lost income, increased overhead, labor and incidental costs and operational inefficiencies.*

THIS WARRANTY CONSTITUTES THE MANUFACTURER’S ENTIRE AND SOLE WARRANTY AND THIS MANUFACTURER EXPRESSLY DISCLAIMS ANY AND ALL OTHER WARRANTIES, INCLUDING, BUT NOT LIMITED TO, EXPRESS AND IMPLIED WARRANTIES AS TO MERCHANTABILITY, FITNESS FOR PARTICULAR PURPOSES SOLD AND DESCRIPTION OR QUALITY OF THE PRODUCT FURNISHED HEREUNDER.

Distributors are not authorized to modify or extend the terms and conditions of this Warranty in any manner or to offer or grant any other warranties for the products in addition to those terms expressly stated above. An officer of the Manufacturer must authorize any exceptions to this Warranty in writing. Manufacturer reserves the right to change models and specifications at any time without notice or obligation to improve previous models.

Effective 08/08

Chore-Time Equipment
A Division of CTB, Inc.
P.O.Box 2000 Milford, Indiana 46542-2000 USA
Ph.: 574-658-4101 Fax: 877-730-8825
Email ctb@ctbinc.com Internet: <http://www.ctbinc.com>



WARNING !

SERIOUS PERSONAL INJURY AND/OR DEATH MAY RESULT FROM USE OF THIS HEATER IN AN UNVENTILATED BUILDING OR IN HUMAN LIVING AREAS.

LE RESULTAT DE MAI DE MORT DE ET/OU DE BLESSURE PERSONNEL SERIEUX DE L'USAGE DE CET APPAREIL DE CHAUFFAGE DANS UN CONSTRUISANT UNVENTILATED OU DANS L'HUMAIN SECTEURS VIVANTS

EL USO DE ESTA CALENTADORA EN UN EDIFICIO SIN VENTILACIÓN O EN UNA AREA HUMANA PUEDE RESULTAR EN ENFERMEDAD Y/O MUERTE

⚠ Do not use the heater to heat human living areas. The intended use of the heater is to provide warmth for poultry and hog buildings.

⚠ Ne pas utiliser l'appareil de chauffage pour chauffer humain habiter les secteurs. L'usage voulu de l'appareil de chauffage sera obligé à

⚠ Use only the type of gas being supplied to the unit as marked on it (Propane or Natural Gas). Do not operate with improper fuel.

⚠ Utiliser seulement le type de gaz étant fourni à l'unité comme marqué dessus (le Propane ou le Gaz Naturel). Ne pas fonctionner

⚠ Before each use, a visual inspection of the heater is essential to insure safe and satisfactory heating. Replace or repair defective components before operating heater. Failure to do so will void warranty and could result in injury or property damage.

⚠ Avant que chaque usage, une inspection visuelle de l'appareil de chauffage est essentielle pour assurer le chauffage sûr et satisfaisant. Remplacer ou réparer des composants le défectueux avant de fonctionner appareil de chauffage. L'échec pour ainsi faire annulera la garantie et pourrait avoir pour résultat les dommages de blessure ou propriété.

⚠ **WARNING:** Improper installation, adjustment, alteration, service or maintenance could cause property damage, injury or death. Read the installation, operating and maintenance instructions thoroughly before installing or servicing this equipment.

⚠ **L'AVERTISSEMENT :** l'installation Déplacée, l'ajustement, le changement, le service ou l'entretien peuvent causer les dommages de propriété, la blessure ou la mort. Lire l'installation, fonctionnant et les instructions d'entretien à fond avant d'installer ou entretenir cet équipement.

⚠ **WARNING** Failure to follow the WARNINGS in this manual could result in serious personal injury or significant property damage.

THESE INSTRUCTIONS SHOULD BE LEFT WITH THE APPLIANCE AND THE USER TO RETAIN FOR FUTURE REFERENCE.

READ THESE INSTRUCTIONS THOROUGHLY BEFORE INSTALLING, USING OR SERVICING THIS EQUIPMENT.

⚠ Before lighting, sniff all around the appliance area for a gas odor. Be sure to sniff next to the floor because propane gas is heavier than air and may temporarily exist at floor level.

Avant d'allumer, renifle tout autour le secteur d'appareil pour une odeur de gaz. Etre sûr de renifler à côté du plancher parce que le gaz de propane est plus lourd que l'air et peut exister temporairement au niveau de plancher.

Antes encender, huele por todas partes el área de aparato para un olor de gas. Esté seguro oler junto al gas de piso porque propano está más pesado que aéreo y puede existir temporalmente en el nivel de piso.

⚠ DO NOT ALLOW POWER CORDS AND/OR GAS SUPPLY HOSES TO REST ON THE CANOPY, HANGING BRACKETS OR OTHER HOT SURFACES OF THE UNIT OR TO COME WITHIN 12" OF THE HEATER.

Ne pas permettre tuyaux à la provision de gaz de et/ou de cordes de pouvoir pour se reposer sur le baldaquin, pendant des crochets ou les autres surfaces chaudes de l'unité Ou venir dans 12" de l'appareil de chauffage.

No permita cuerdas de poder y/o mangas de suministro de gas para descansar en el dosel, colgando paréntesis u otras superficies calientes de la unidad O para venir dentro de 12" de la calentadora..

⚠ DSI UNITS MUST BE PROPERLY GROUNDED. DO NOT ALTER ELECTRICAL CORD.

LES UNITES DE DSI DOIVENT ETRE CONVENABLEMENT FONDE. Ne PAS CHANGER LA CORDE ELECTRIQUE.

Las UNIDADES de DSI se DEBEN PONER EN TIERRA APROPIADAMENTE. No ALTERE CUERDA ELECTRICA.

⚠ Plug in the three-prong power cord to a correctly grounded three-prong electrical outlet.

Brancher sur le cordon d'alimentation de trois-broche à un a fondé correctement la trois-broche sortie électrique.

Conecte la cuerda de tres polos del poder a un molíó correctamente salida eléctrica de tres polos.

⚠ The installation of this appliance must in all cases conform with local and national building codes or in the absence of local codes with the current National Fuel Gas Code ANSI Z223.1/NFPA 54, or the Natural Gas and Propane Installation Codes, CSA B149.1 and B149.2.

L'installation de cet appareil doit dans tous cas conforme avec les codes de bâtiment locaux et nationaux ou en l'absence de codes locaux avec le Carburant le Gaz le Code ANSI Z223.1/NFPA National actuel 54, ou le Gaz Naturels et le Codes d'Installation de Propane, CSA B149.1, B149.2

La instalación de este aparato debe en todos casos se conforma con códigos locales y nacionales de edificio o en ausencia de códigos locales con el Código Nacional actual de Gas de Combustible ANSI Z223.1/NFPA 54, o el Gas natural y Códigos de Instalación de Propano, CSA B149.1, B149.2

⚠ Heaters must be electrically grounded in accordance with the National Electrical Code, ANSI/NFPA 70 or the current Canadian Electrical Code, CSA C22.1. Polarity of Line voltage and neutral wires must be maintained. The total load of all heaters in a circuit must be considered for overload control of that circuit. Power supply must have earth ground.

Les appareils de chauffage doivent être électriquement fondé conformément au Code Electrique National, ANSI/NFPA 70 ou le Code Electrique, canadien et actuel, CSA C22.1. La polarité de tension de Ligne et de fils neutres doit être maintenue. Le chargement total de tous appareils de chauffage dans un circuit doit être considéré pour le contrôle de surcharge de ce circuit.

Las calentadoras basado en eléctricamente la conformidad con el Código Eléctrico Nacional, ANSI/NFPA 70 o el Código Eléctrico, canadiense y actual, CSA C22.1. La polaridad del voltaje de la Línea y alambres neutrales se debe mantener. La carga total de todas calentadoras en un circuito se debe considerar para el control de sobrecarga de ese circuito.

LARGE INFRARED BROODER- PARTS LIST & ASSEMBLY INSTRUCTIONS

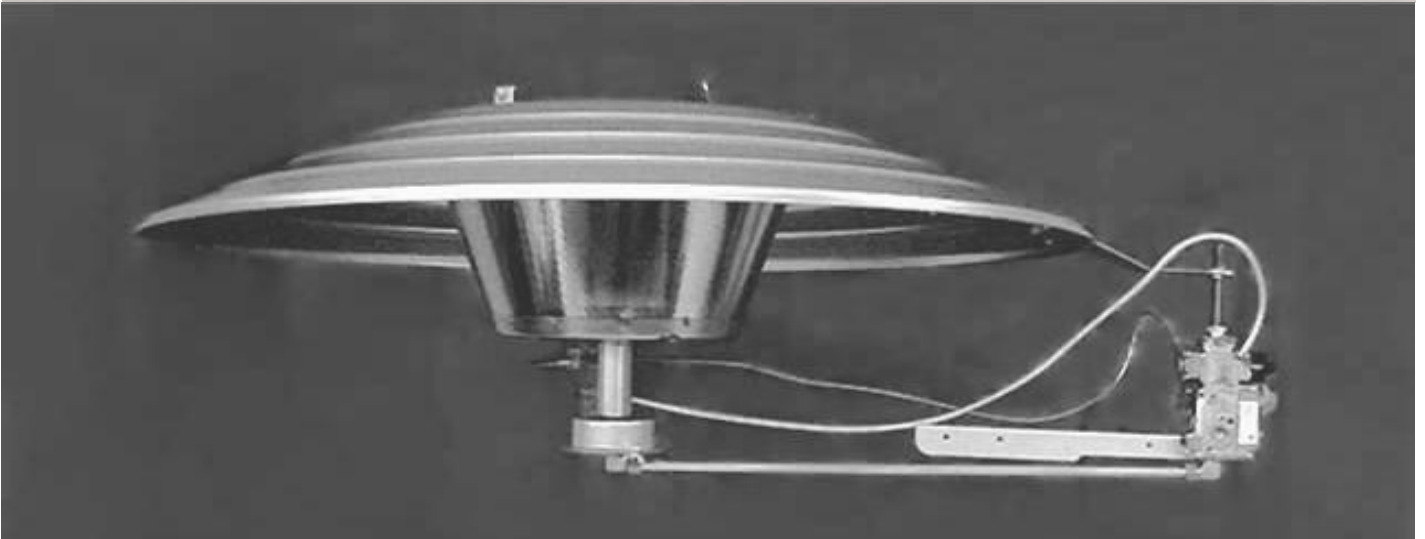

TOOLS REQUIRED FOR ASSEMBLING BROODER :
Phillips Screwdriver, Open End Wrenches (3/8, 5/8,
7/16, 9/16, 1/2, 11/16 7/8), Nut Driver 5/16, Pliers
and an adjustable wrench.



Tested and Evaluated
by C.S.A. International.

⚠ Before lighting, sniff all around the appliance area for a gas odor. Be sure to sniff next to the floor because propane gas is heavier than air and may temporarily exist at floor level.

Avant d'allumer, renifle tout autour le secteur d'appareil pour une odeur de gaz. Etre sûr de renifler à côté du plancher parce que le gaz de propane est plus lourd que l'air et peut exister temporairement au niveau de plancher.

Antes encender, huele por todas partes el área de aparato para un olor de gas. Esté seguro oler junto al gas de piso porque propano está más pesado que aéreo y puede existir temporalmente en el nivel de piso.

⚠ DO NOT ALLOW POWER CORDS AND/OR GAS SUPPLY HOSES TO REST ON THE CANOPY, HANGING BRACKETS OR OTHER HOT SURFACES OF THE UNIT OR TO COME WITHIN 12" OF THE HEATER.

Ne pas permettre tuyaux à la provision de gaz de et/ou de cordes de pouvoir pour se reposer sur le baldaquin, pendant des crochets ou les autres surfaces chaudes de l'unité Ou venir dans 12" de l'appareil de chauffage.

No permita cuerdas de poder y/o mangas de suministro de gas para descansar en el dosel, colgando paréntesis u otras superficies calientes de la unidad O para venir dentro de 12" de la calentadora..

⚠ DSI UNITS MUST BE PROPERLY GROUNDED. DO NOT ALTER ELECTRICAL CORD.

LES UNITES DE DSI DOIVENT ETRE CONVENABLEMENT FONDE. Ne PAS CHANGER LA CORDE ELECTRIQUE.

Las UNIDADES de DSI se DEBEN PONER EN TIERRA APROPIADAMENTE. No ALTERE CUERDA ELECTRICA.

⚠ Plug in the three-prong power cord to a correctly grounded three-prong electrical outlet.

Brancher sur le cordon d'alimentation de trois-broche à un a fondé correctement la trois-broche sortie électrique.

Conecte la cuerda de tres polos del poder a un molió correctamente salida eléctrica de tres polos.

⚠ The installation of this appliance must in all cases conform with local and national building codes or in the absence of local codes with the current National Fuel Gas Code ANSI Z223.1/NFPA 54, or the Natural Gas and Propane Installation Codes, CSA B149.1 and B149.2.

L'installation de cet appareil doit dans tous cas conforme avec les codes de bâtiment locaux et nationaux ou en l'absence de codes locaux avec le Carburant le Gaz le Code ANSI Z223.1/NFPA National actuel 54, ou le Gaz Naturels et le Codes d'Installation de Propane, CSA B149.1, B149.2

La instalación de este aparato debe en todos casos se conforma con códigos locales y nacionales de edificio o en ausencia de códigos locales con el Código Nacional actual de Gas de Combustible ANSI Z223.1/NFPA 54, o el Gas natural y Códigos de Instalación de Propano, CSA B149.1, B149.2

⚠ Heaters must be electrically grounded in accordance with the National Electrical Code, ANSINFPA 70 or the current Canadian Electrical Code, CSA C22.1. Polarity of Line voltage and neutral wires must be maintained. The total load of all heaters in a circuit must be considered for overload control of that circuit.

Les appareils de chauffage doivent être électriquement fondé conformément au Code Electrique National, ANSINFPA 70 ou le Code Electrique, canadien et actuel, CSA C22.1. La polarité de tension de Ligne et de fils neutres doit être maintenue. Le chargement total de tous appareils de chauffage dans un circuit doit être considéré pour le contrôle de surcharge de ce circuit.

Las calentadoras basado en eléctricamente la conformidad con el Código Eléctrico Nacional, ANSINFPA 70 o el Código Eléctrico, canadiense y actual, CSA C22.1. La polaridad del voltaje de la Línea y alambres neutrales se debe mantener. La carga total de todas calentadoras en un circuito se debe considerar para el control de sobrecarga de ese circuito.



16550142 for valve models

PARTAS BAG



16550120 for DSI

	16-104093 BRKT : UNIVERSAL BROODER CONTROL
	16-10335 Washer. 3/8 X 11/4 Fen
	16-11176 LOCKNUT: HEX STEEL
	18003945 SCREW 10-24 X 3/8"
	18000021 NUT 10-24 STAR KEP
	11000118 NUT COMP SLEEVE 1/4
	11000191 COMP NUT 1/4
	18000658 COMP SLEEVE 3/8
	18000657 COMP NUT 3/8
	11010033 CANOPY 34" HDA 11011008 CANOPY 34" GALV.
	11000030 CONE INSULATION INFRARED 42
	16550065 LARGE INFRARED EMITTER ASSM.
	16550068 BURNER ASM. LP PILOT 16550069 BURNER ASM. NAT PILOT 16550070 BURNER ASM. DSI LP 16550071 BURNER ASM. DSI NAT

	16-101443 NUT: HEX 10-24 18.8SS
	11004900 S HOOK LARGE
	21004002 BACK "T" HANGER
	21014002 FRONT "T" HANGER
	11000187 1/2-20 NUT
	11000028 1/2-20 X 5/8 BOLT
	11000338 1/2-20 WASHER LOCK SPLIT
	28024042 PILOT BODY FINISHED
	16550048 CLIP F/RING W/LEGS
	13005235 SCREW 8 X 1/2 TEK
	16-111 DISC: AIR PORT LP
	13005190 NUT 10-24 WING
	16-101069 ELL: BRASS 3/8 COMP X 1/8 MPT
	11010215 LP ORIFICE #48 11010210 NAT ORIFICE #37 HA42
	21007088 PILOT BRKT SQ PILOT
	21002400 SHIELD: CONTROL HEAT

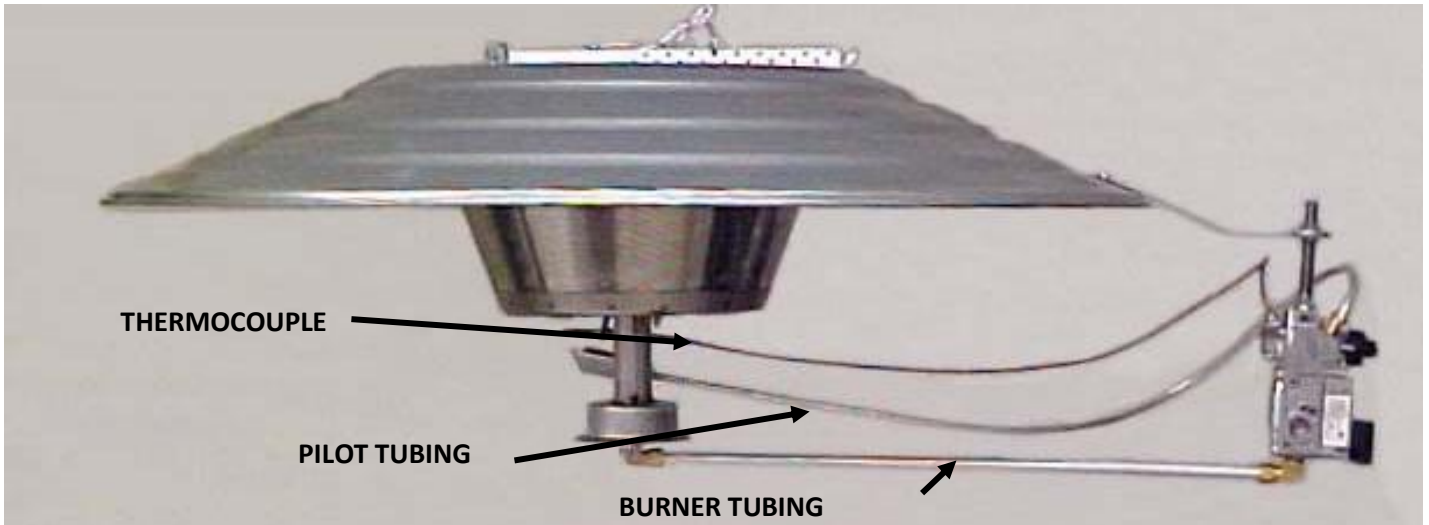

	<p>31044002 PILOT ASM INFRARED LP CGA 31034002 PILOT ASM INFRARED NAT CGA</p>
<p>BURNER TUBING</p>	
<p>PILOT TUBING</p>	

	<p>16-1102 DISC AIR RESTRICTOR NAT</p>
	<p>11002205 LP ORIFICE #78 11002203 NAT ORIFICE #73</p>
<p>FOR INDIVIDUAL MODELS BURNER TUBING - 16000003 TUBE ALUM PILOT TUBING - 21260326 TUBE ALUM 1/4 X .032 X 32</p>	
<p>FOR 7000 VALVE ZONE MODELS BURNER TUBING - 16000001 TUBE ALUM 3/8X.035X20 1/2 PILOT TUBING - 21260326 TUBE ALUM 1/4X.032X32</p>	
<p>FOR DSI MODELS BURNER TUBING - 16000003 TUBE ALUM 3/8X.035X32</p>	

11000663 THERMOCOUPLE: 30"

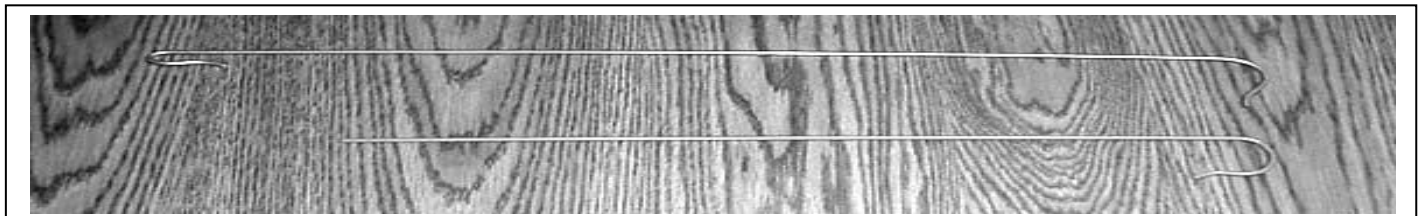
CGA ONLY

16500082 - TUBE PROTECTOR IND & ZONE

16500083 - TUBE PROTECTOR LG INF DSI

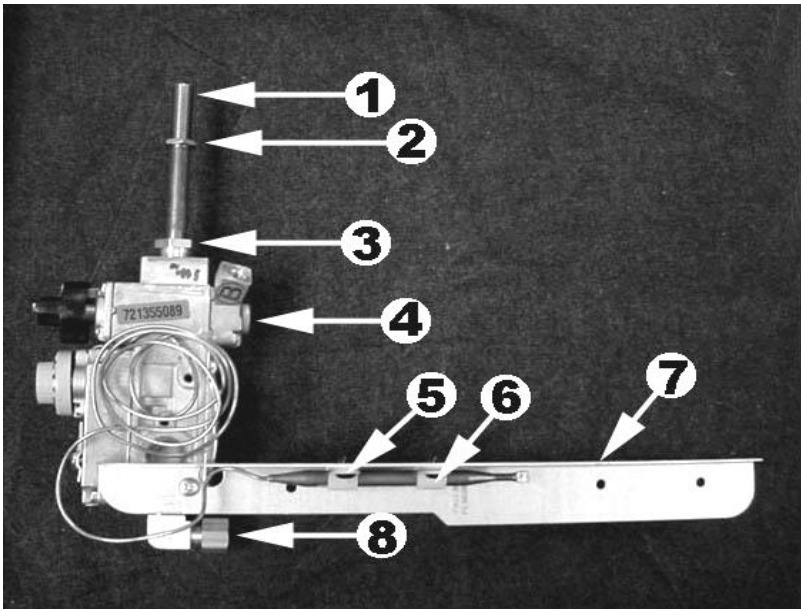

16500165 – CTRL AMS : LP & NAT

- | | | |
|----|-------------|----------------------------|
| 1. | 16000000 | NIPPLE GALV 1/8 X 3-1 |
| 2. | 16-11176 | LOCKNUT HEX STEEL |
| 3. | 16-11194 | BUSHING: GALV STDHEX |
| 4. | 16000106 | VALVE 7000 SLC |
| 5. | 16000036 | RIVET: NYLON PUSH-IN RIVET |
| 6. | 11000033 | CLAMP WIRE NYLON |
| 7. | 16-104219 | SHIELD: UNIVERSAL BRDR |
| 8. | 16-10052950 | ELL: BRASSV3/8MPTX3/8COM |

Not shown – 11003995 – comp nut & sleeve ¼ » (same as #2 in illustration below)

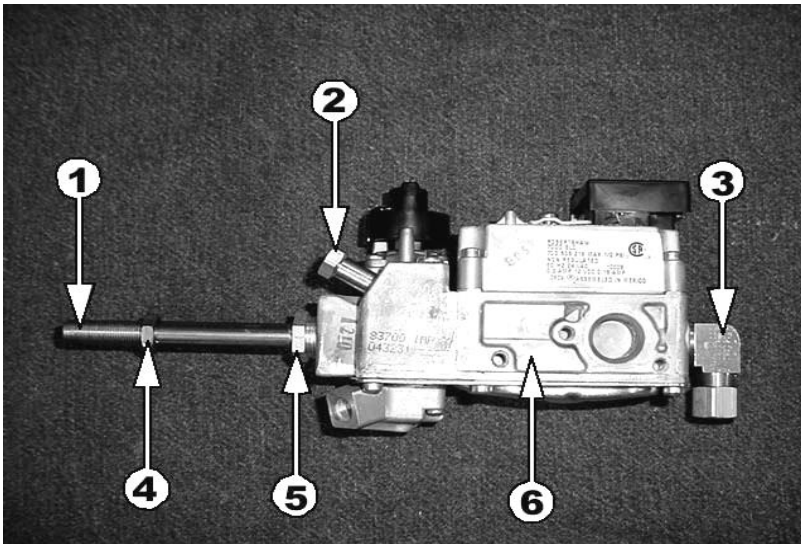

16-104443 –SG RZ CTRL ASM

- | | | |
|----|-------------|------------------------------|
| 1. | 16000000 | – 1/8 X 3 ½ Galv. Pipe |
| 2. | 11003995 | COMP NUT & SLEEVE ¼” |
| 3. | 16-10052950 | ELL : BRASS 3/8MPT X3/8COMP |
| 4. | 16-11176 | LOCKNUT HEX STEEL |
| 5. | 16-11194 | BUSHING: GALV STDHEX 1/2X1/8 |
| 6. | 11004081 | BARE VALVE 7000 ELC |

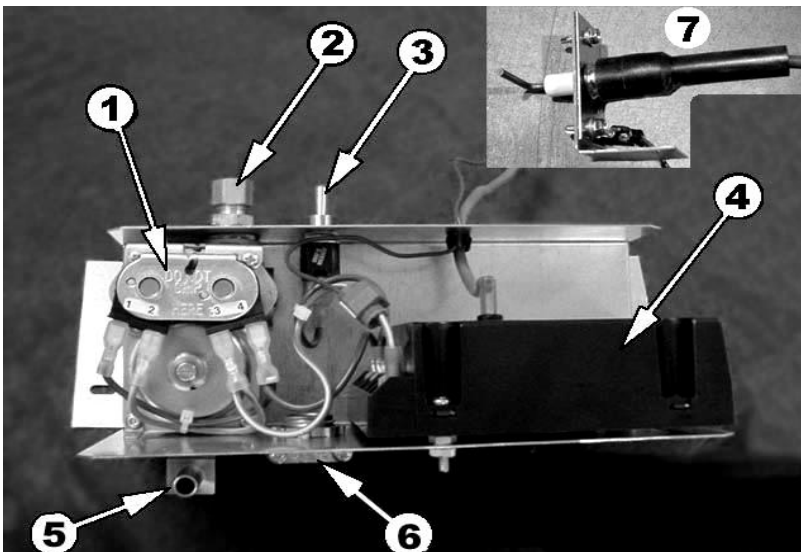

31003025 DSI CTRL ASM

- | | | |
|-----|-----------|--|
| 1. | 11001238 | VALVE WR 25M FOR DSI |
| 2. | 11000643 | CONN BRASS
3/8 MPT X 3/8 COMP |
| 3. | 13005282 | SWITCH TOGGLE SP/ST |
| 4. | 16-101068 | BOARD: CTRL IGN DSI |
| 5. | 11003838 | ELBOW BRASS
3/8 MPT X 3/8 HOSE BARB |
| 6. | 13005072 | WIRE STRAIN RELIEF |
| 7. | 16-101197 | IGNITOR DSI SINGLE |
| 8. | 21106077 | CONTROL BOX BOTTOM |
| 9. | 23004502 | IGNITER BRACKET |
| 10. | 16500145 | GROUND WIRE ASSY |
| 11. | 11003030 | WIRE HARNESS |
| 12. | 13005235 | SCREW 8 X ½ TEK |
| 13. | 13008108 | STRAIN RELIEF |
| 14. | 21116077 | CONTROL BOX COVER |



1) Place CONE INSULATION inside the EMITTER

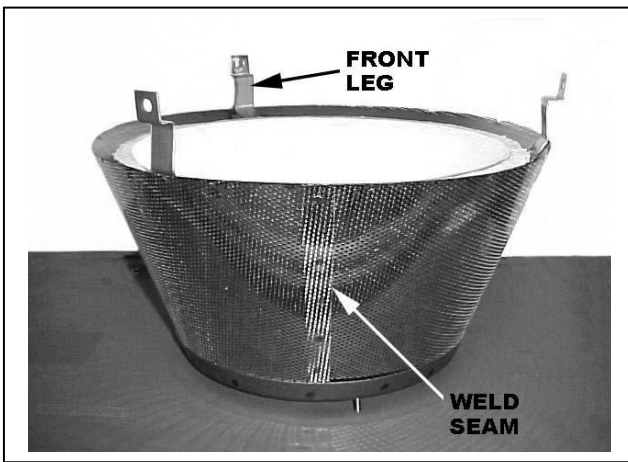

2) Place the CANOPY over the Emitter legs with two holes in the outer edge of the canopy aligned with the front leg.

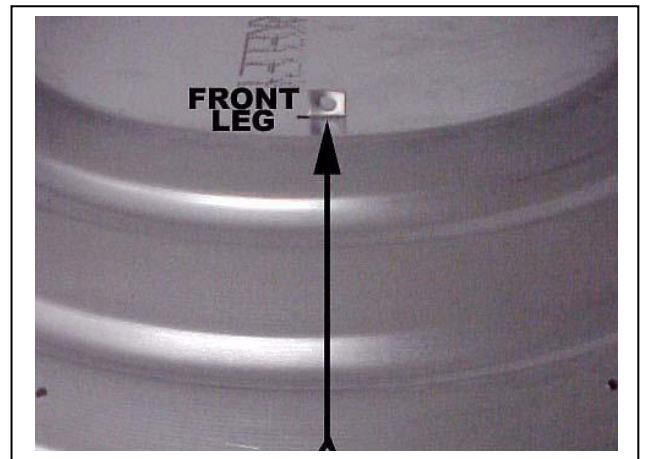

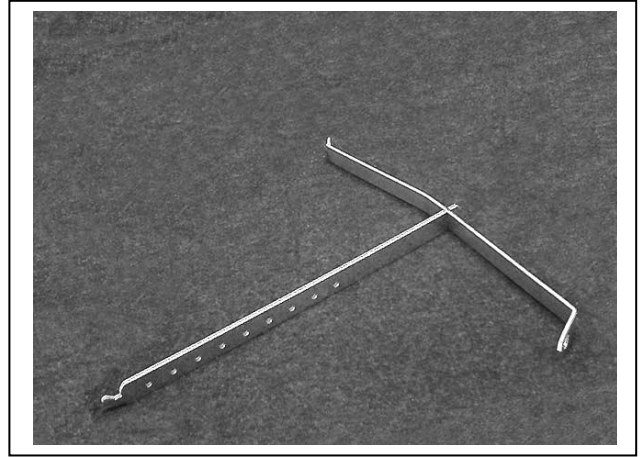
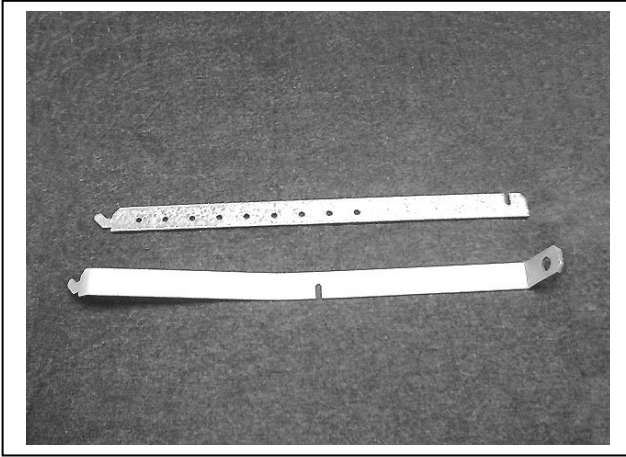

3) Insert the slot in the middle of the BACK T-HANGER into the slot in the end of the FRONT T-HANGER.

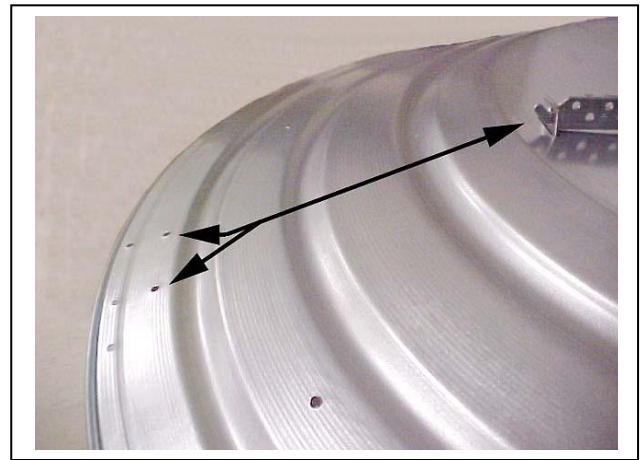

Hanger should be on the outside of the emitter leg.

4) Insert hooks through the holes in the emitter legs.

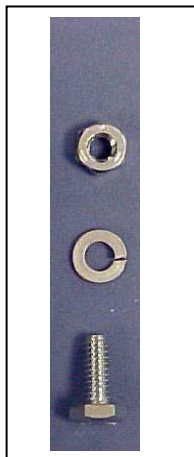
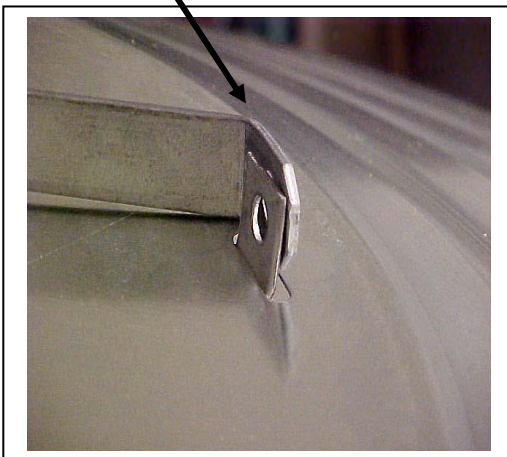

Secure with ¼ BOLT WASHER, and NUT.



1) Slide BURNER into EMITTER.



2) Insert edge of burner into slots.



PILOT INLET MUST FACE TOWARD THE HOLES IN THE CANOPY.

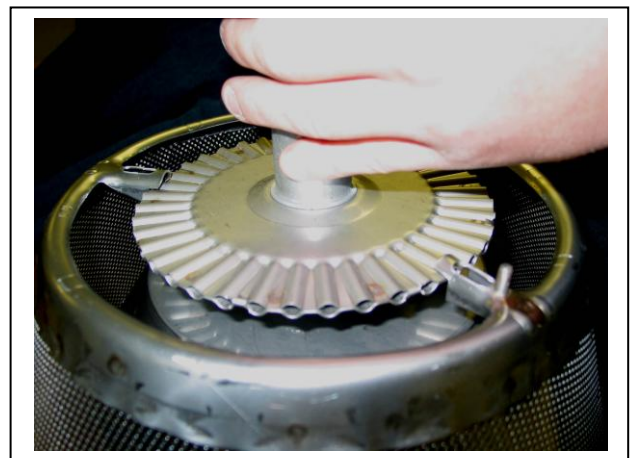

3) Lift burner into position as shown.



4) Slide clip legs under burner, hole over pem stud.

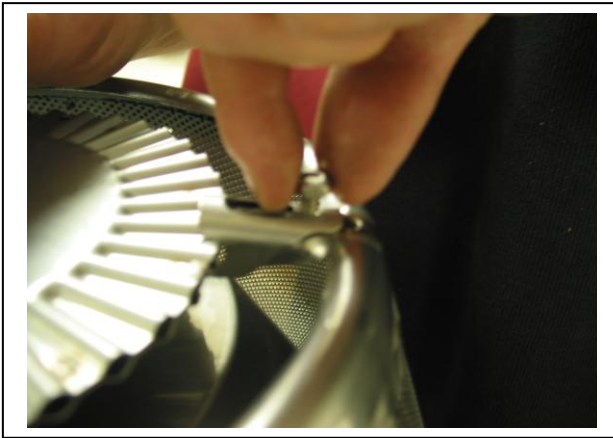

5) Secure burner to Emitter with 10/24 SS nut.

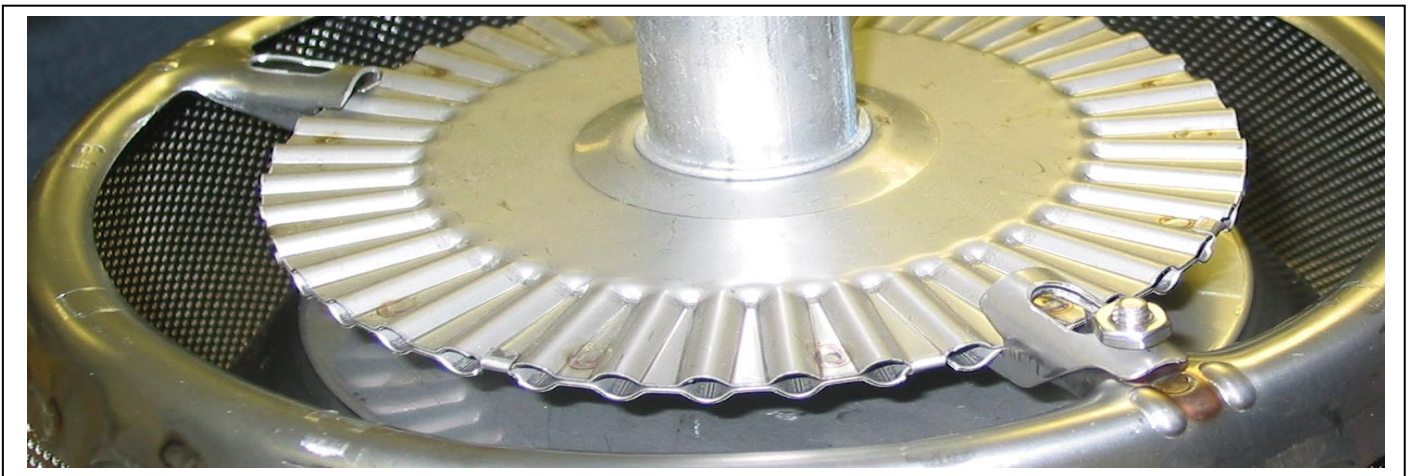

THIS PAGE FOR ZONE CONTROL

FOR INDIVIDUAL CONTROL, SEE PAGE 19

FOR DSI CONTROL, SEE PAGE 24

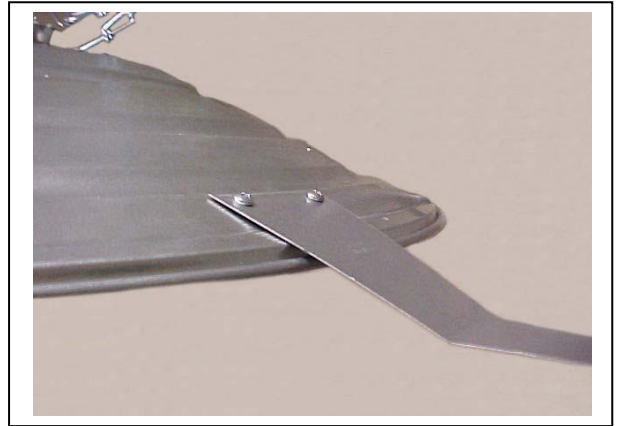
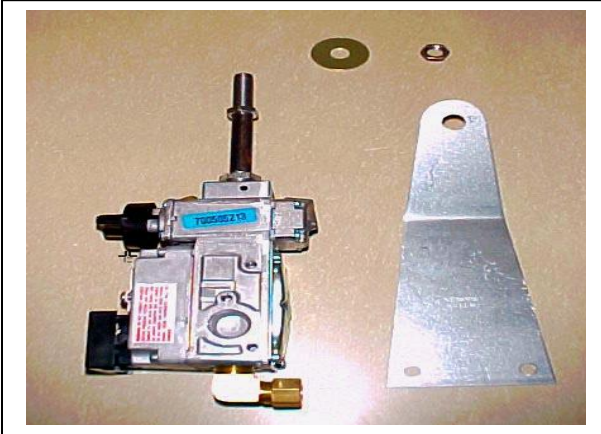

- 7) Attach BRACKET to top of CANOPY with two 10/24 SCREWS and NUTS.

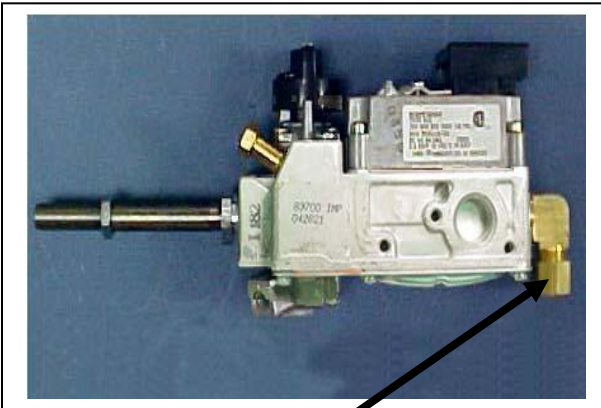

Remove nut and sleeve.

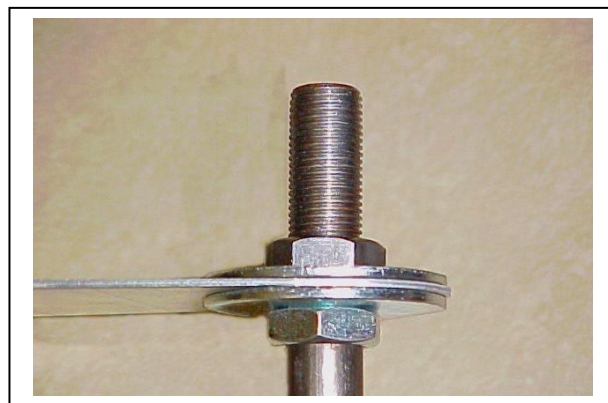
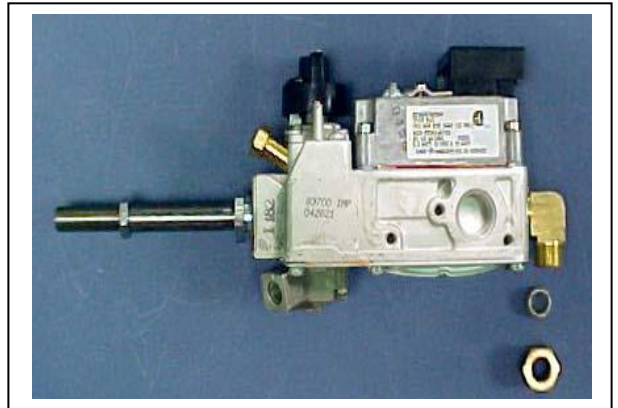

- 8) Place one WASHER on pipe and insert through BRACKET from the underside. Secure with second WASHER and one Nut. Valve should hang straight.

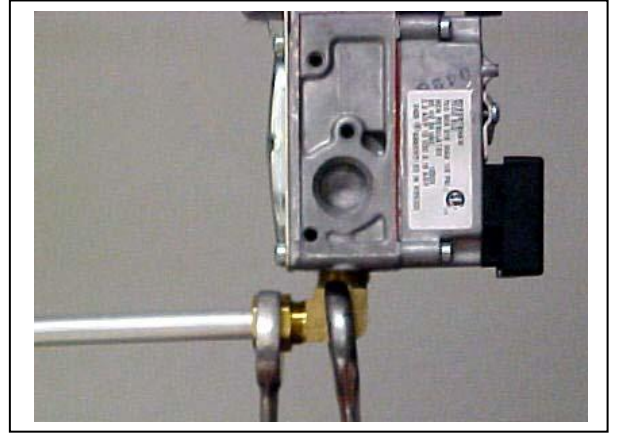
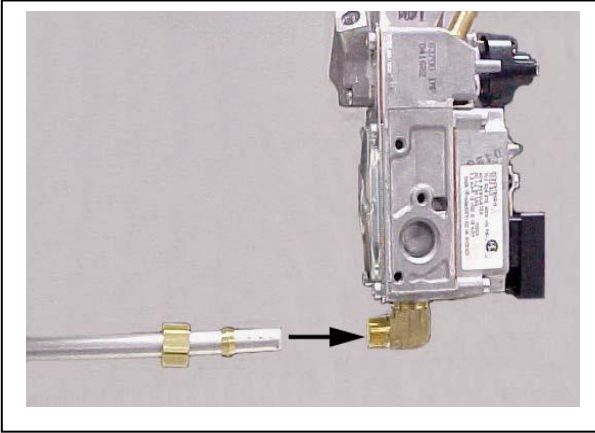

9) Attach BURNER TUBING to control valve using two wrenches to prevent damaging tubing.

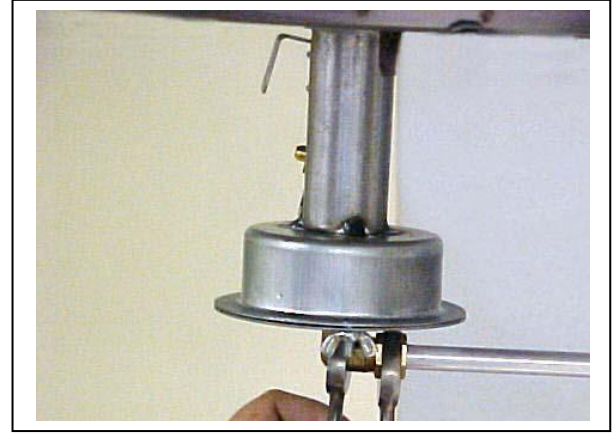
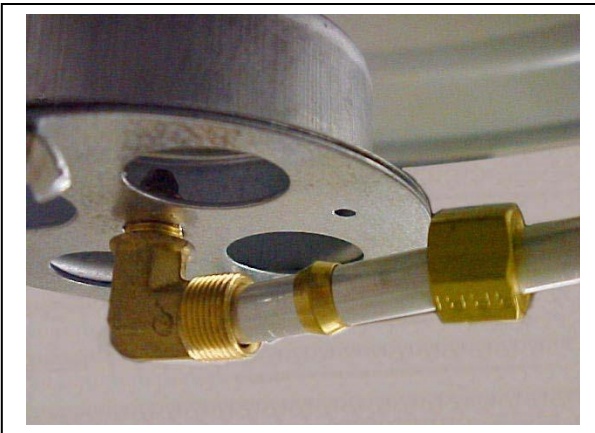

10) Attach BURNER TUBING to burner. Use two wrenches to avoid damage to burner.

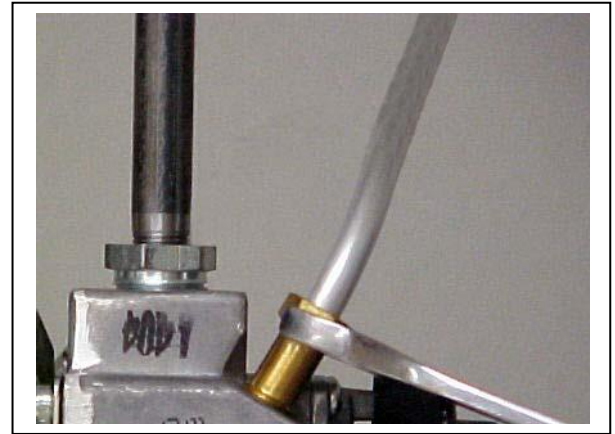
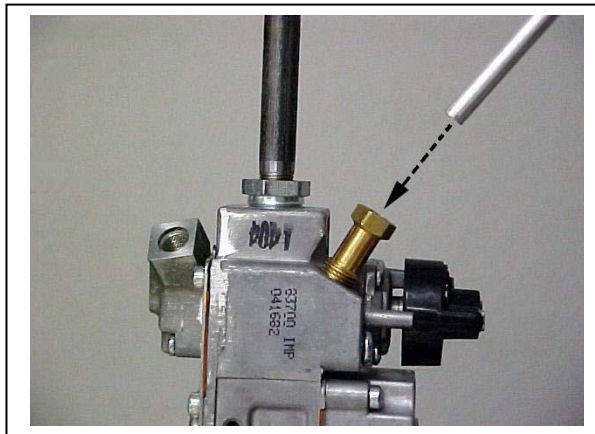

11) Attach PILOT TUBING to control valve.

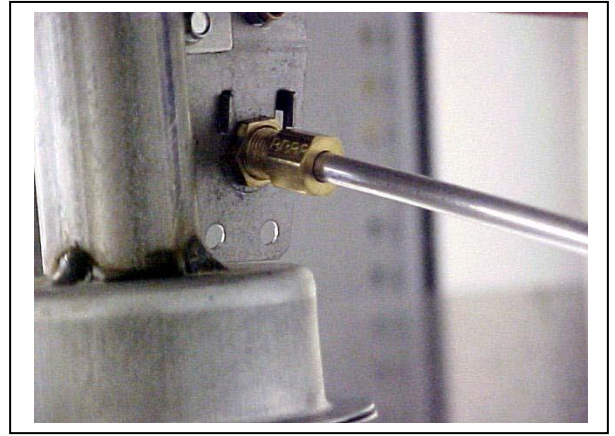
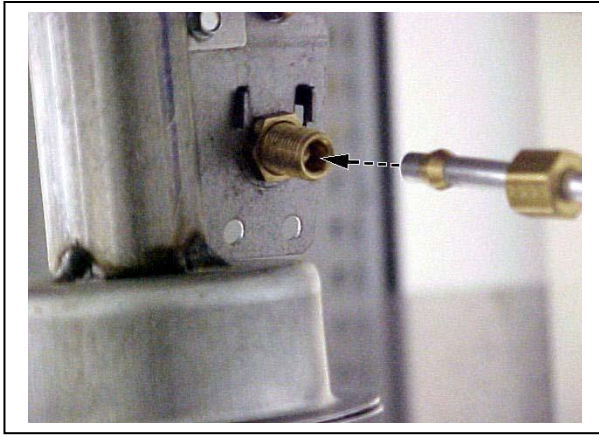

12) Attach PILOT TUBING to PILOT ORIFICE.

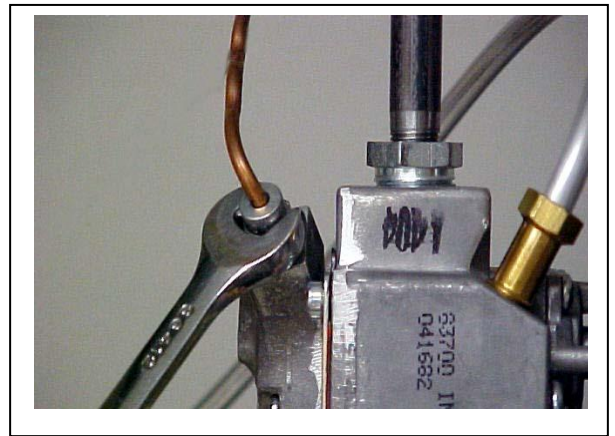
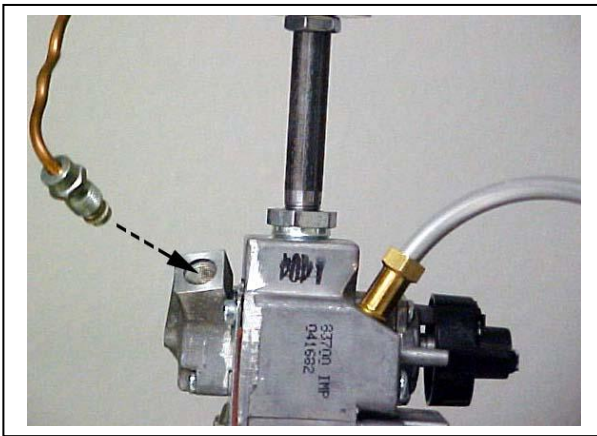

13) Attach THERMOCOUPLE to CONTROL VALVE. Finger tight plus ¼ turn to avoid damaging.

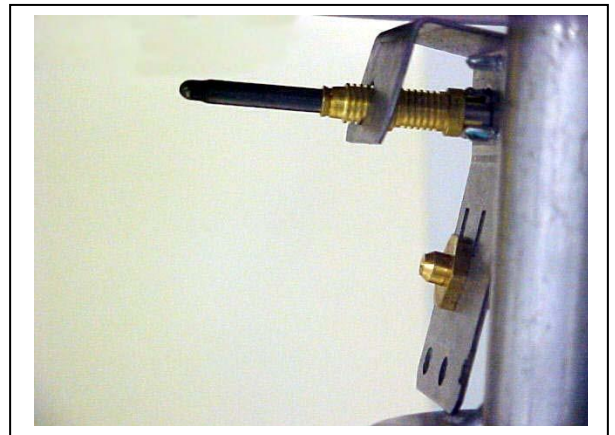

14) Insert THERMOCOUPLE into the PILOT BRACKET.

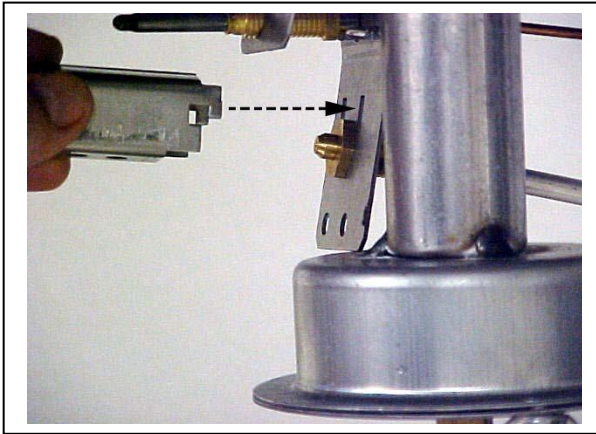

15) Attach PILOT SHIELD to PILOT BRACKET.

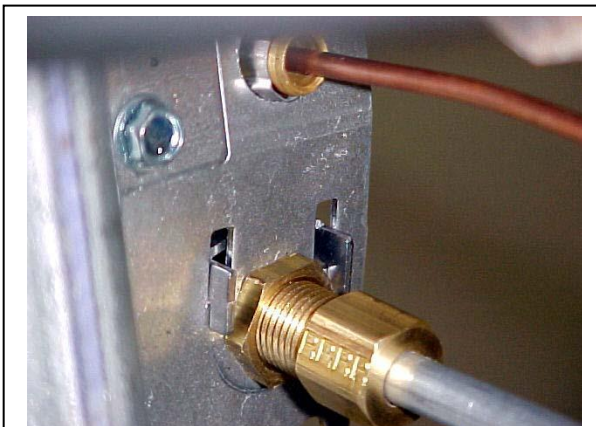
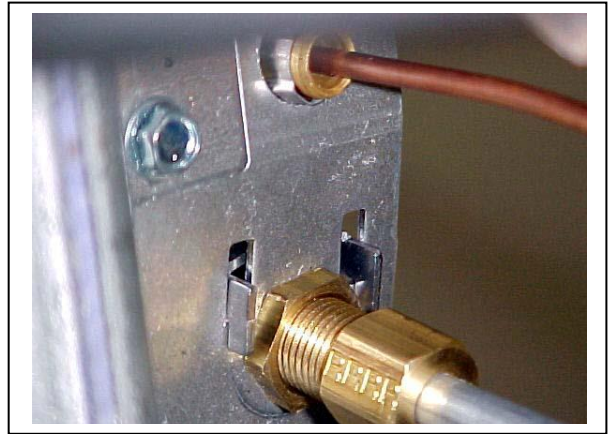

Lock shield into place by pressing down on shield, hooks on shield will slide down past the opening in the pilot bracket.

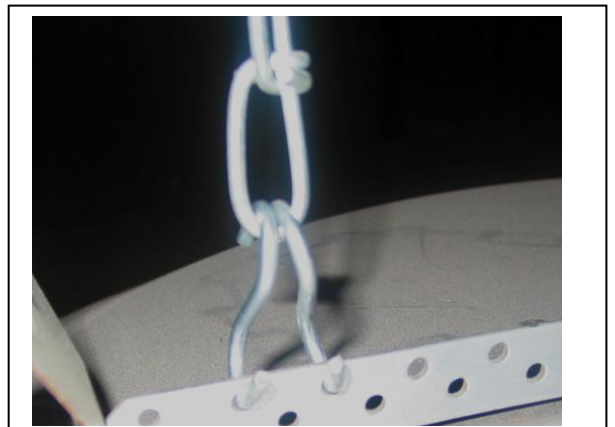

Note: Two S Hooks should be used to adjust tilt between holes if needed.

SUSPEND THE HEATER

To level the unit, support the heater underneath and then move the s-hook forward and backward. We recommend that the valve side of the canopy be slightly lower (1" -2") to insure that the gas valve does not overheat. After it is level, clamp both ends of the s-hook shut. Normally the heater is attached to a winch cable used for lowering and raising.

In addition we require that a safety cable or chain be attached to prevent the heater from falling to the litter if the cable should break.

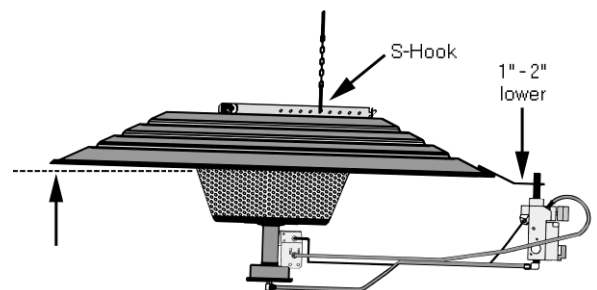

The heater must be located so that there is a minimum clearance of 14" above the heater and 36" from the sides. Any combustible material must not be adjacent to the heater. The heater should be hung with a minimum clearance of 60" from the edge of the canopy or 48" from the bottom of the pan to the floor.

Installer **MUST** comply with all local, state, and federal gas codes for your area.

It is recommended that the regulator be sized to 130% of the load it is supplying. Gas layout and pipe sizing guidelines are available through your distributor.

GAS PRESSURE should be CHECKED and ADJUSTED to recommended settings.

1. Connect the gas hose to the unit using hose clamps. (not provided)
2. Turn on gas supply to the unit and check all fittings and connections for leaks with a gas sensing meter or soap solution. Burner connections can only be checked with the burner burning.

WARNING!

 Failure to comply with all applicable local and federal gas codes could result in serious personal injury and/or serious property damage.

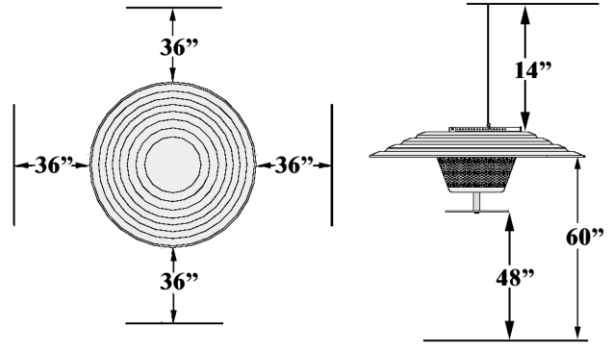

LP GAS:

FIRST – go to the furthest stove from the regulator and connect the pressure gauge to the Press Tap on the gas valve. Light only the stove you are testing or if you have a zone system light all the stoves in the zone. Set the pressure at a maximum of 11¼" WC.

SECOND – light all stoves in the house and check the pressure again. The pressure should not drop below 10½" WC. If the pressure does fall below 10½" WC, then the gas distribution system is inadequately designed. The problem may be a regulator, pipe sizing, etc.

NATURAL GAS:

Use same procedure as LP gas above, except the pressure should not exceed 7¼" WC, with only one stove or zone operating. The pressure should not drop below 6½" WC with all stoves running.

Lighting instructions for Individual SNAP

Control

1. Turn gas dial "OFF" and connect main gas supply to supply pipe.
2. Turn gas to "PILOT".
3. Depress and hold "RESET" button and light the pilot. Allow pilot to burn for 45 seconds before releasing.
4. Turn gas dial "ON" and turn the Zone thermostat to desired setting.

TO SHUT OFF HEATER

Turn the gas dial to "OFF" and the zone thermostat dial to lowest setting.



DANGER!

DO NOT ALLOW POWER CORDS AND/OR GAS SUPPLY HOSES TO REST ON THE CANOPY HANGING BRACKETS OR OTHER HOT SURFACES OF THE UNIT OR TO COME WITHIN 12" OF THE HEATER.

During and after winching make certain that ALL hoses and power supply cords are NOT on heaters nor are within 12" of the heaters.

INDIVIDUAL CONTROL INSTRUCTIONS

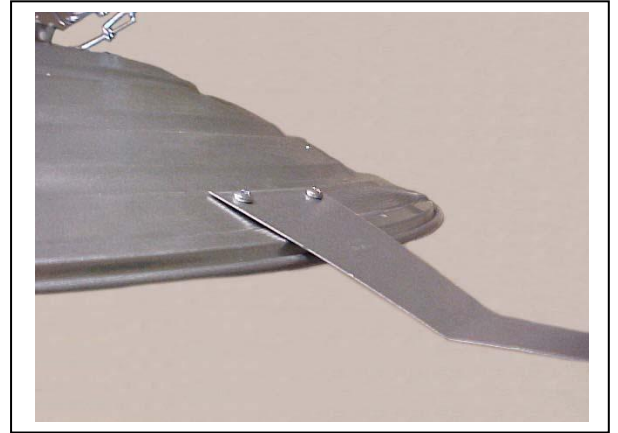
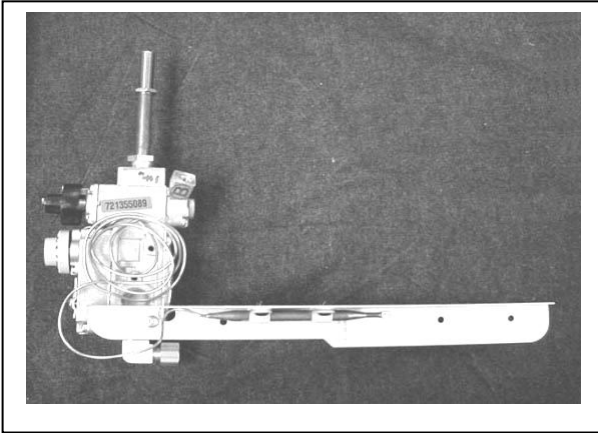

- 1) Attach BRACKET to CANOPY with two 10-24 SCREWS and NUT

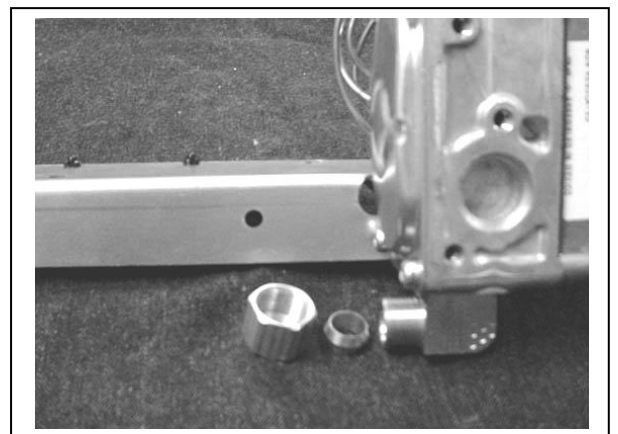
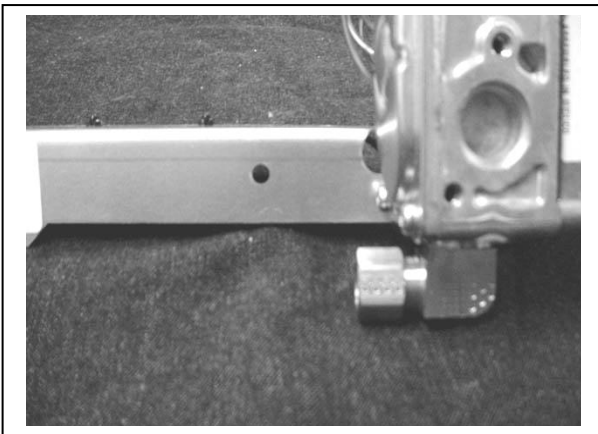
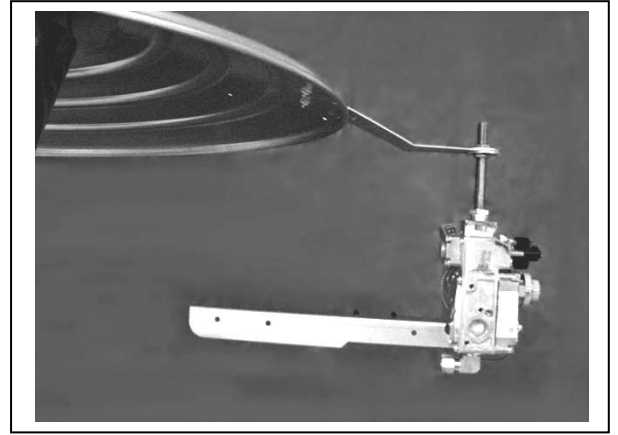
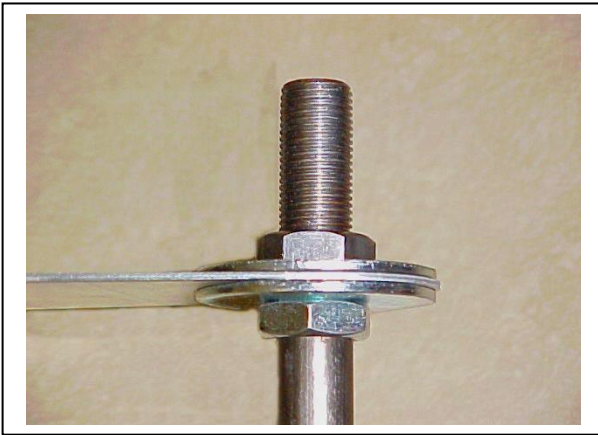

- 2) Remove nut and sleeve.

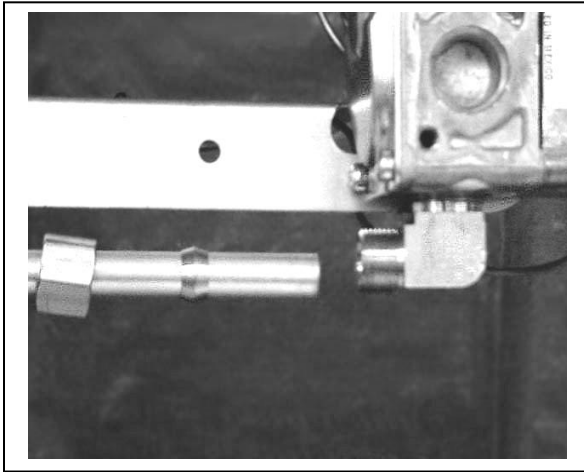

3) Attach BURNER TUBING to control valve using two wrenches to prevent damaging tubing

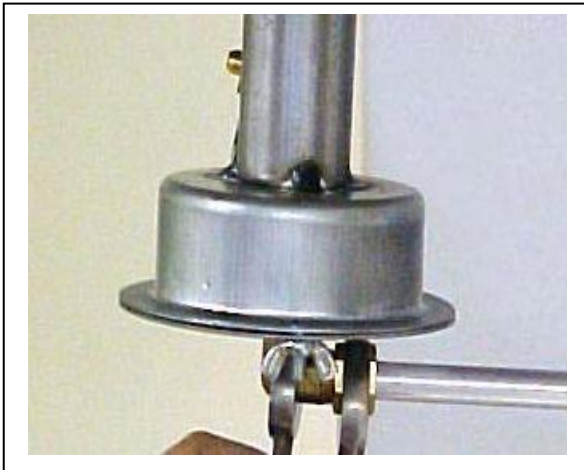
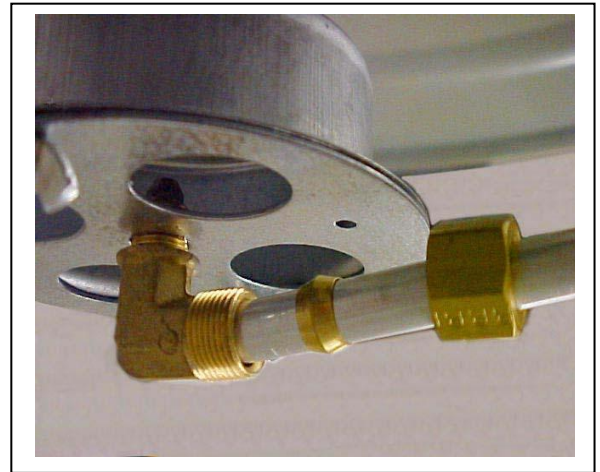

4) Attach BURNER TUBING to burner. Use two wrenches to avoid damage to burner.

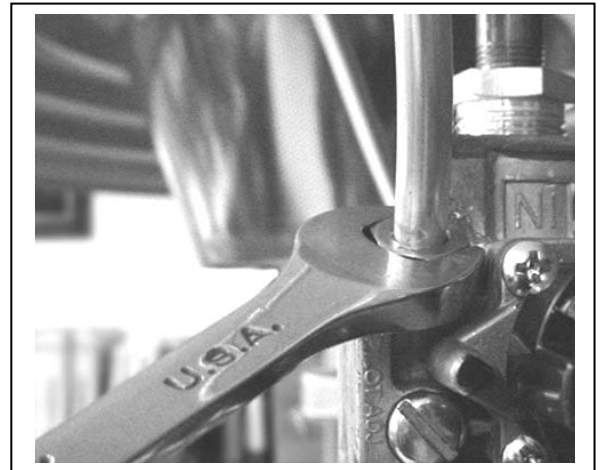

5) Attach PILOT TUBING.

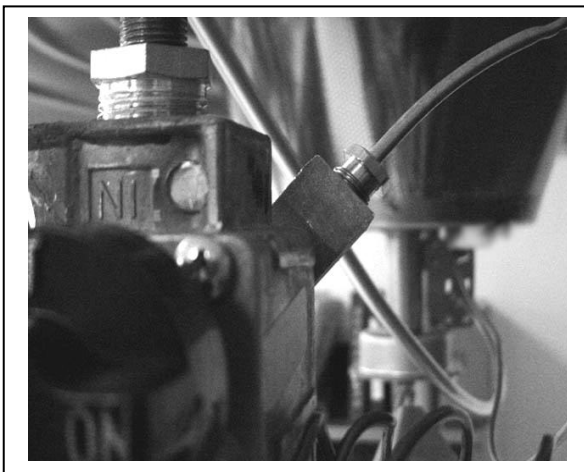

6) Attach THERMOCOUPLE. Finger tight plus ¼ turn to avoid damaging ceramic.



SUSPEND THE HEATER

To level the unit, support the heater underneath and then move the s-hook forward and backward. We recommend that the valve side of the canopy be slightly lower (1" -2") to insure that the gas valve does not overheat. After it is level, clamp both ends of the s-hook shut. Normally the heater is attached to a winch cable used for lowering and raising.

In addition we require that a safety cable or chain be attached to prevent the heater from falling to the litter if the cable should break.

The heater must be located so that there is a minimum clearance of 14" above the heater and 36" from the sides. Any combustible material must not be adjacent to the heater. The heater should be hung with a minimum clearance of 60" from the edge of the canopy or 48" from the bottom of the pan to the floor.

FOR CGA ONLY:

Individual and Zone Brooders

Attach tubing protector by hooking the narrow loop end around the pipe nipple on the valve and snapping the wide loop end around the burner, between the pan and the air intake cup.

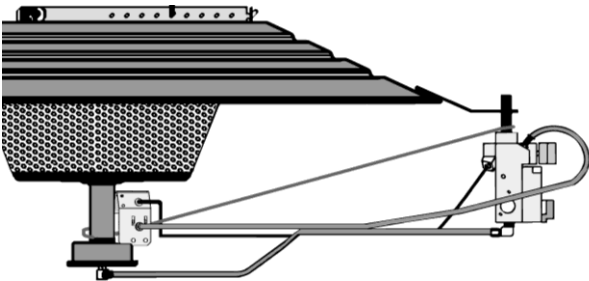

GAS PRESSURE should be CHECKED and ADJUSTED to recommended settings.

1. Connect the gas hose to the unit using hose clamps. (not provided)
2. Turn on gas supply to the unit and check all fittings and connections for leaks with a gas sensing meter or soap solution. Burner connections can only be checked with the burner burning.

LP GAS:

FIRST – go to the furthest stove from the regulator and connect the pressure gauge to the Press Tap on the gas valve. Light only the stove you are testing or if you have a zone system light all the stoves in the zone. Set the pressure at a maximum of 11¼" WC.

SECOND – light all stoves in the house and check the pressure again. The pressure should not drop below 10½" WC. If the pressure does fall below 10½" WC, then the gas distribution system is inadequately designed. The problem may be a regulator, pipe sizing, etc.

NATURAL GAS:

Use same procedure as LP gas above, except the pressure should not exceed 7¼" WC, with only one stove or zone operating. The pressure should not drop below 6½" WC with all stoves running.

Lighting instructions for Individual SNAP

Control

1. Turn gas dial "OFF" and connect main gas supply to supply pipe.
2. Turn gas to "PILOT".
3. Depress and hold 'RESET" button and light the pilot. Allow pilot to burn for 45 seconds before releasing.
4. Turn gas dial "ON" and turn the Zone thermostat to desired setting.

TO SHUT OFF HEATER

Turn the gas dial to "OFF" and turn the temperature dial to "1" or lowest setting.

24 VOLT ZONE BROODERS/HEATERS

1. Mount "Auto-Switch-Over" (A.S.O.) Power supply in convenient location near electrical panel and WITHIN 3 FEET OF OUTLET. Outlet should be separately fused – 15 AMP.
2. Mount junction box over each thermostat location selected.
3. Run 14-2 romex from connections on A.S.O. to nearest junction box and continue on to other.
4. Run 14-2 romex over each line of brooders to be hooked up to Zone Control. Line should be run adjacent the gas line. If more than one thermostat (zone) is to be use black wire should be cut between zones.
5. Choose either 5a or 5b for connecting your thermostat to the power pack.
 - a. Cut outer insulation ONLY on romex over each brooder to expose black and white wires. DO NOT CUT OR STRIP WIRES. Bare ground wire is not used. Using "T" tap connectors, connect wire from brooder valve (24V) to romex – white to white; black to black. Note—cut off excess wire from valve. Tape wire to ;gas hose and romex to make a neat installation.
 - b. With one wire nut connect black from feed (A.S.O.), back to the next junction box (if used), and back from thermostat. With another wire nut connect white from feed (A.S.O.), white to the next junction box (if used), and white from line over brooders. Finally connect white from thermostat to black from line over brooders.
6. Light brooder in usual manner and set ZONE thermostat for desired temperature.
7. Check for any voltage drops to brooder.

Warning !

-  Failure to comply with all applicable local, state, and federal gas codes could result in serious personal injury and/or serious property damage.

Warning !

-  Failure to follow the instructions in this manual could result in serious personal injury or property damage.

DANGER!



DO NOT ALLOW POWER CORDS AND /OR OTHER GAS SUPPLY HOSES TO REST ON THE CANOPY, HANGING BARCKETS OR OTHER HOT SURFACES OF THE UNIT OR TO COME WITHIN 12" OF THE HEATER.
During and after winching, make certain that ALL hoses and power supply cords are NOT resting on the heater not ate within 12" of the heater.

MAINTENANCE

BEFORE PERFORMING ANY MAINTENANCE ON THE HEATER, MAKE CERTAIN THAT ALL POWER AND FUEL HAS BEEN SHUT OFF TO THE UNIT.

Proper care and maintenance of your brooder cannot be over emphasized!!

A POORLY MAINTAINED HEATER WILL:

- Raise Operating Costs- due to poor combustion.
 - Lower Air Quality
- Cause Inconsistent Temperatures
- Decrease the Life of the Heater

CAUTION

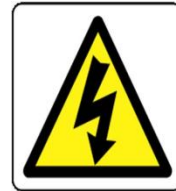

MAINTENANCE PROGRAM

-Daily: Check burner, it should be burning clear and blue; if not, clean as required or check gas pressure.

Note: $\frac{3}{4}$ " yellow tip is a common characteristic of the flame on this brooder.

-Clean brooder/heater after each flock
Inspect for any orifice blockage caused by spider webs in the burner assemblies.

DANGER! Never spray penetrating oil (WD-40) on the control valve. This will cause the loss of high temperature valve grease and cause the valve to leak.

- Clean dust and dirt from burner ports with compressed air. If an air compressor is not available turn the brooder/heater to a vertical position and tap on the side of the burner with a screwdriver, pliers, or any other suitable object, to knock the dust from the unit.
If houses are washed down, care should be taken to prevent moisture from accumulating on control valve and burner assemblies.
- Cover valve and burner assemblies with plastic before washing.
- After wash downs remove plastic from brooder/heater.
- Do not allow radiant to become wet.
- We recommend that you light the brooders/heaters to dry up any excess moisture.
- For proper combustion it is important that the small holes in the Emitter be clean and unobstructed.
- The Emitter can be cleaned by inserting a long brass bristle brush between the outer and inner cones.
- Clean air intakes with a small brush.
- Extreme care must be taken not to enlarge or distort the burner orifices.
- If brooder/heater is disconnected from the gas line, use tape to seal the open connections. This will keep moisture, dust, and insects out and prevent future problems.
- Dust that accumulates on the canopy should be cleaned off before igniting brooder. If dust is left to burn off of galvanized canopies it will result in loss of galvanizing material and corrosion of the canopy.

DSI CONTROL INSTRUCTIONS

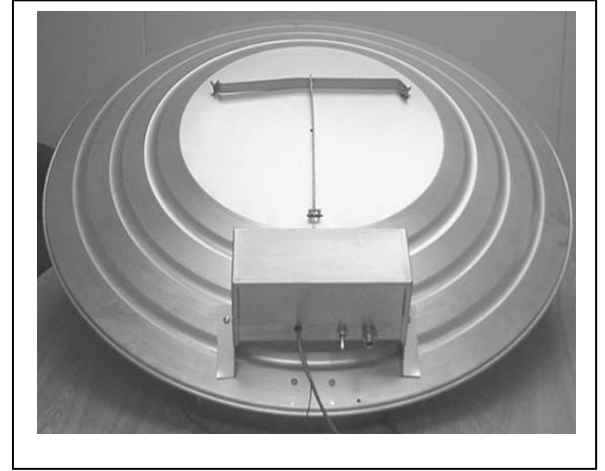

- 1) Attach DSI control TOP side of canopy using screw and star washers. On/Off switch MUST face to the outer edge of the canopy.

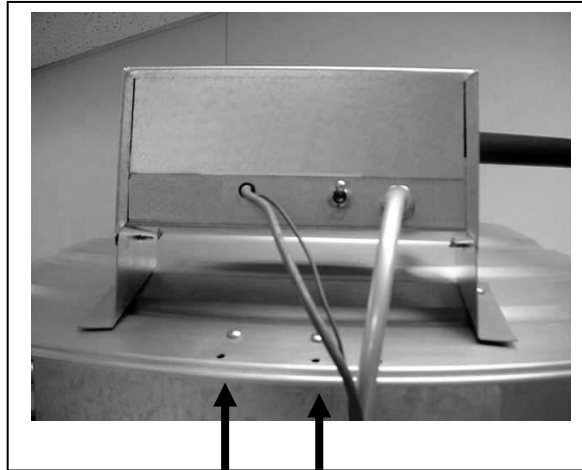

- 2) Attach shield to the UNDERSIDE of the canopy using hardware supplied, in the holes shown.

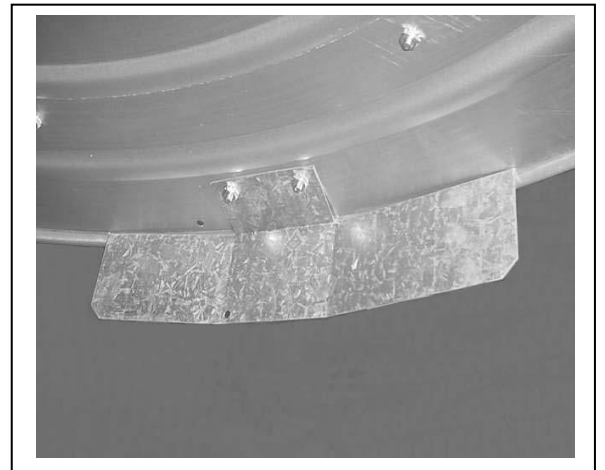

- 3) Secure ignitor bracket to burner as shown using tek screws. Bracket can be adjusted to align ignitor with gas port. **DO NOT BEND IGNITOR ROD.**

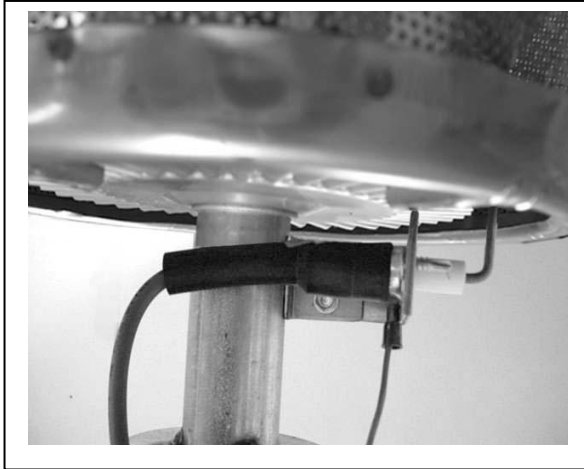

Ignitor bracket should be installed so that ignitor rod is in front of a gas port with the tip of the ignitor even with or above port.

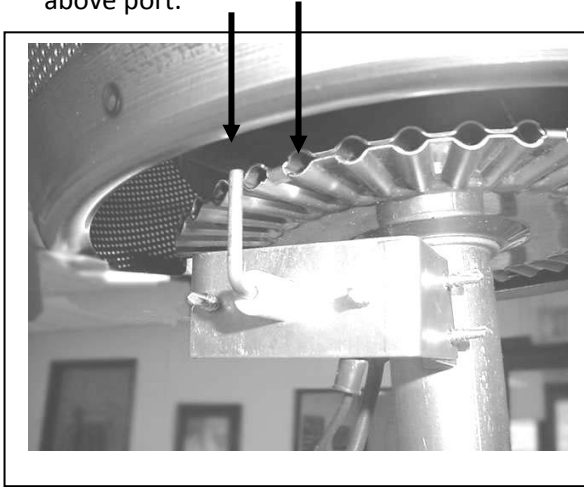

Ignitor rod should be approximately 1/8" from gas port.



- 4) Remove brass nut and sleeve.

5) Insert tubing into brass fitting. Use wrench to tighten brass compression nut.



6) Hand form tubing to connect to burner. To avoid damaging burner, use two wrenches to tighten brass fitting. Secure wires to tubing using wire ties. **DO NOT WRAP WIRE AROUND TUBING. DO NOT CLOSE TIES TO TIGHTLY ON WIRES.**

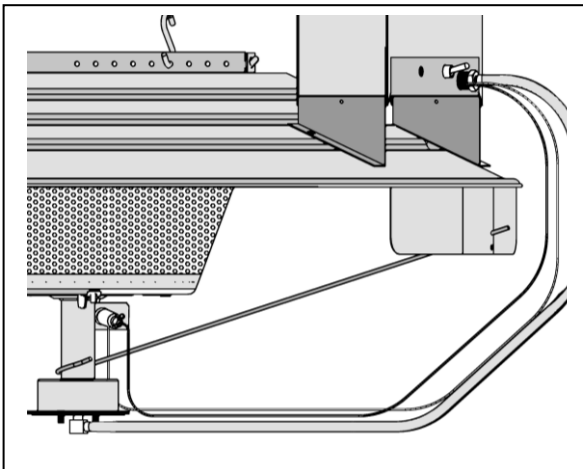

FOR CGA ONLY:
Attach tubing protector by hooking looped end around burner base and inserting other end through hole in heat shield.

TO CONNECT POWER TO DSI UNIT:

Insert wire through the romex connector located on the back of the assembly.

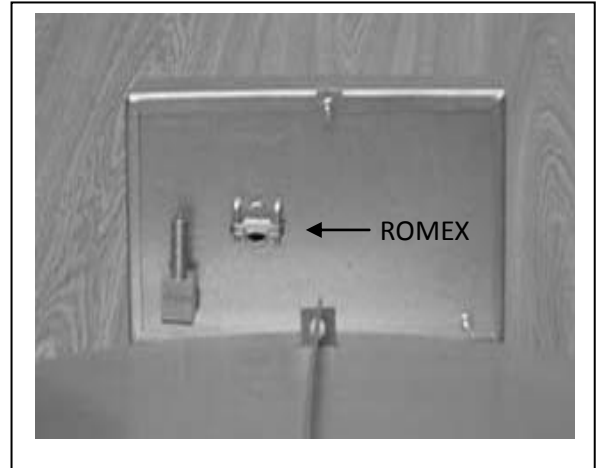

Connect the ground wire to the first terminal on the control board using the pre-installed empty blue connector. Crimp wire in connector.

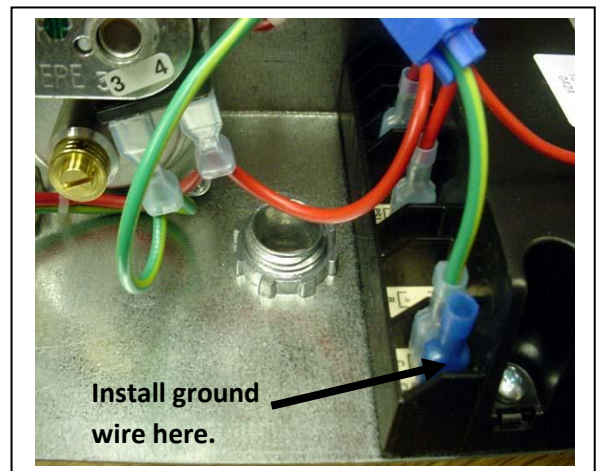

Connect the positive wire to the empty blue connector pre-installed on the toggle switch. Crimp wire connector.

Install
positive
wire here

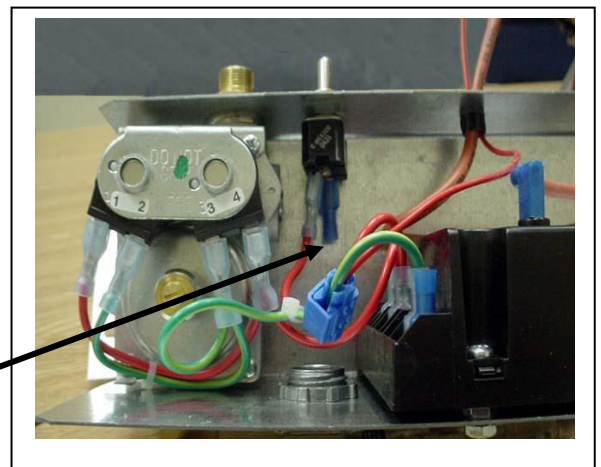

SUSPEND THE HEATER

To level the unit, support the heater underneath and then move the s-hook forward and backward. We recommend that the valve side of the canopy be slightly lower (1" -2") to insure that the gas valve does not overheat. After it is level, clamp both ends of the s-hook shut. Normally the heater is attached to a winch cable used for lowering and raising.

In addition we require that a safety cable or chain be attached to prevent the heater from falling to the litter if the cable should break.

The heater must be located so that there is a minimum clearance of 14" above the heater and 36" from the sides. Any combustible material must not be adjacent to the heater. The heater should be hung with a minimum clearance of 60" from the edge of the canopy or 48" from the bottom of the pan to the floor. Be sure to comply with all local, state and federal gas codes for your area.

CONNECTING THE GAS HOSE TO THE UNIT.

Attach the hose (use only CGA approved gas hose assembly in accordance with CGA/CGA - B149.1 and B149.2) from the gas supply to the hose barb on the control using hose clamps (not provided). Check all connections for leaks before lighting brooder. Turn on gas supply to the unit and check all fittings and connections for leaks with Gas Sensing Meter and/ or soap solution.

Note: The burner connections can only be checked with the burner burning.

DANGER!

DO NOT ALLOW POWER CORDS AND /OR GAS SUPPLY HOSES TO REST ON THE CANOPY, HANGING BRACKETS OR OTHER HOT SURFACES OF THE UNIT OR TO COME WITHIN 12" OF THE HEATER.

During and after winching, make certain that ALL hoses and power supply cords are NOT resting on the heater nor are within 12" of the heater.

GAS PRESSURE should be CHECKED and ADJUSTED to recommended settings.

1. Connect the gas hose to the unit using hose clamps. (not provided)
2. Turn on gas supply to the unit and check all fittings and connections for leaks with a gas sensing meter or soap solution. Burner connections can only be checked with the burner burning.

LP GAS:

FIRST – go to the furthest stove from the regulator and connect the pressure gauge to the Press Tap on the gas valve. Light only the stove you are testing or if you have a zone system light all the stoves in the zone. Set the pressure at a maximum of 11¼" WC. SECOND – light all stoves in the house and check the pressure again. The pressure should not drop below 10½" WC. If the pressure does fall below 10½" WC, then the gas distribution system is inadequately designed. The problem may be a regulator, pipe sizing, etc.

NATURAL GAS:

Use same procedure as LP gas above, except the pressure should not exceed 7¼" WC, with only one stove or zone operating. The pressure should not drop below 6½" WC with all stoves running.

LIGHTING INSTRUCTIONS

1. Move toggle switch to "OFF" position and connect electrical supply to brooder.
2. Move the toggle switch to "ON" and turn the thermostat to desired position.

TO TURN UNIT OFF :

1. Turn off the gas.
2. Move toggle switch to the "OFF" position.

TROUBLESHOOTING TABLE

<u>Problem:</u>	<u>Possible Solution:</u>
Brooder does not light.	Use the torch to try to light brooder. If it lights with the torch and not the spark, then electrode is in wrong position or not sparking properly.
Brooder fires and goes out within a few seconds.	Improper grounding. Check chassis ground wire connection.
Brooder fires with a puff after a few seconds delay.	Electrode out of position, shorting to metalwork. The spark should be at the tips of electrode and in front of burner ports.
If it still does not light.	Check output of board to valve (voltage). (24 VAC) Check status of valve. Is solenoid working? (Check for continuity) If solenoid is sticking, tap top with screwdriver. Check Coil / Solenoid continuity. If not open, then O.K.
Brooders in zone fire when adjacent zone fires, even though one zone is not calling for heat.	Wiring is inconsistent. LV1 and LV2 have been interchanged. The switched Thermostat/Computer contact must feed terminal W on the DSI Board. (SEE WIRING DIAGRAM)

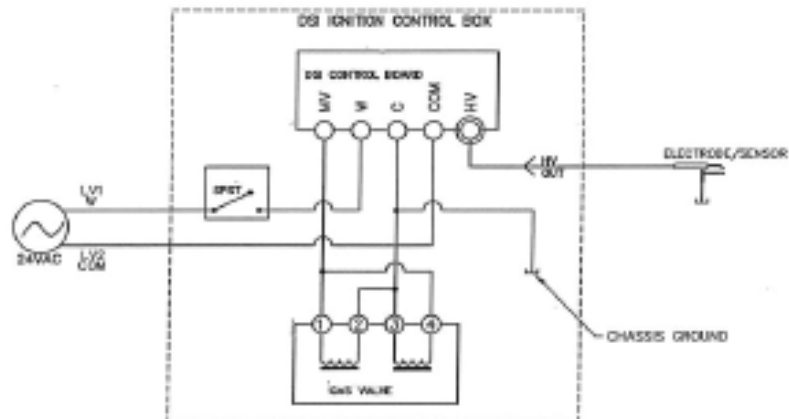

TROUBLESHOOTING THE DSI BOARD.

To maintain correct operation the polarity of W & COM must be maintained.
The DSI Board controls the following parts:

- Spark - good or bad
 - Output to gas control valve.
 - Flame Sensing
 - Spark gap = 7/64".
 - Position sparking at gas flow.
 - If no spark - check wire condition.
- Tight Connections
 - Wire.
 - Nuts & Bolts.
 - Good chassis ground.
 - Ground between box & burner.
 - Continuity between box and post or electrode.
- Thermostat
 - Switch W.

DIRECT SPARK IGNITION TROUBLE CODES *

<u>LED Flashing</u>	<u>Possible Cause</u>	<u>Corrective Action</u>
3 Flashes	No ignition, False flame detected or GV output not matching drive.	Check fuel supply, Check ignitor, Check gas valve
4 Flashes	Too many flame losses within one call for heat; Improper flame sensing drive.	Check air flow (flame blown away from ignitor)*

*Must remove cover on Control Box to check trouble codes. Trouble Codes are erased when power is cycled off. Board flashes trouble codes when Brooder is in Lock Out condition (See Above)

DSI TROUBLE SHOOTING

1. Verify gas pressure. 11" WC for LP. 7" WC for NAT.
2. Be sure wiring is heavy enough, 12-2 or 14-2 on trunk lines, from junction box to heaters can be 18 GA lamp cord or SJ cable.
3. Check for proper voltage. 24 – 27 VAC, no less than 20 VAC, with all brooders on.
4. BE SURE POLARITY IS CORRECT TO ALL BROODERS. (see wiring diagram.)
5. Check for stray voltage, can be present on winch system.
6. Check electrode placement in flame.
 - a. Check for loose electrode in ceramic.
 - b. Check electrode distance to burner tube, 1/8 – 3/16"
7. Check spark – sensor electrode for corrosion, clean with steel wool.
8. Check spark and sensor wire for good installation, no tickling your hand, also check for continuity & no resistance, stretch wire slightly while checking.
9. If spark is intermittent remove plastic ties holding wire to tubing. If OK, bad wire.
10. If there is brooder failure, check for blinking light on electronic board. See page 31 for codes.